

## Table of Contents

<b>Introduction</b>	<b>4</b>
<b>Instrument Cluster</b>	<b>12</b>
Warning and control lights	12
Gauges	17
<b>Entertainment Systems</b>	<b>19</b>
AM/FM stereo with single CD	19
AM/FM stereo with in-dash six CD	23
<b>Climate Controls</b>	<b>30</b>
Manual heating and air conditioning	30
<b>Lights</b>	<b>32</b>
Headlamps	32
Turn signal control	35
Bulb replacement	37
<b>Driver Controls</b>	<b>42</b>
Windshield wiper/washer control	42
Steering wheel adjustment	43
Power windows	47
Mirrors	49
Traction control	50
<b>Locks and Security</b>	<b>57</b>
Keys	57
Locks	57
Anti-theft system	64

<b>Table of Contents</b>	
<b>Seating and Safety Restraints</b>	<b>69</b>
Seating	69
Safety restraints	77
Airbags	93
Child restraints	106
<b>Tires, Wheels and Loading</b>	<b>118</b>
Tire Information	122
Tire Inflation	123
Vehicle loading	135
Trailer towing	142
Recreational towing	147
<b>Driving</b>	<b>148</b>
Starting	148
Brakes	153
Transmission operation	157
<b>Roadside Emergencies</b>	<b>173</b>
Hazard flasher switch	173
Fuses and relays	174
Changing tires	180
Lug Nut Torque	191
Overheating	192
Jump starting	193
Wrecker towing	198
<b>Customer Assistance</b>	<b>200</b>
<b>Cleaning</b>	<b>211</b>

## Table of Contents

<b>Maintenance and Specifications</b>	<b>217</b>
Engine compartment	226
Engine oil	229
Battery	233
Engine Coolant	235
Fuel information	241
Air filter(s)	255
Refill capacities	257
Engine data	259
<b>Accessories</b>	<b>264</b>
<b>Index</b>	<b>265</b>

All rights reserved. Reproduction by any means, electronic or mechanical including photocopying, recording or by any information storage and retrieval system or translation in whole or part is not permitted without written authorization from MNAO. MNAO may change the contents without notice and without incurring obligation.

Copyright © 2005 MNAO

## Introduction

### CALIFORNIA Proposition 65 Warning

**WARNING: Engine exhaust, some of its constituents, and certain vehicle components contain or emit chemicals known to the State of California to cause cancer and birth defects or other reproductive harm. In addition, certain fluids contained in vehicles and certain products of component wear contain or emit chemicals known to the State of California to cause cancer and birth defects or other reproductive harm.**

### CONGRATULATIONS

Congratulations on acquiring your new Mazda product. Please take the time to get well acquainted with your vehicle by reading this handbook. The more you know and understand about your vehicle, the greater the safety and pleasure you will derive from driving it.

For more information on Mazda and its products visit the following website:

- In the United States: [www.mazdausa.com](http://www.mazdausa.com)
- In Canada: [www.mazda.ca](http://www.mazda.ca)

Additional owner information is given in separate publications.

This Owner's Guide describes every option and model variant available and therefore some of the items covered may not apply to your particular vehicle. Furthermore, due to printing cycles it may describe options before they are generally available.

Remember to pass on the Owner's Guide when reselling the vehicle. It is an integral part of the vehicle.

**WARNING: In the event of an accident the Fuel pump shut-off switch will automatically cut off the fuel supply to the engine. The switch can also be activated through sudden vibration (e.g. collision when parking). To reset the switch, refer to the *Fuel pump shut-off switch* in the *Roadside Emergencies* chapter.**

## Introduction

### SAFETY AND ENVIRONMENT PROTECTION

#### Warning symbols in this guide

How can you reduce the risk of personal injury to yourself or others? In this guide, answers to such questions are contained in comments highlighted by a bold **WARNING** statement. These comments should be read and observed.



#### Warning symbols on your vehicle

When you see this symbol, it is imperative that you consult the relevant section of this guide before touching or attempting adjustment of any kind.



#### Protecting the environment

We must all play our part in protecting the environment. Correct vehicle usage and the authorized disposal of waste, cleaning and lubrication materials are significant steps towards this aim. Information in this respect is highlighted in this guide with the tree symbol.



Always dispose of used automotive fluids in a responsible manner. Follow your community's regulations and standards for recycling and disposing of automotive fluids.

## Introduction

### **BREAKING-IN YOUR VEHICLE**

There are no particular breaking-in rules for your vehicle. During the first 1,000 miles (1,600 km) of driving, vary speeds frequently. This is necessary to give the moving parts a chance to break in.

### **SPECIAL NOTICES**

#### **Event Data Recorder**

The computer in your vehicle is capable of recording detailed data potentially including but not limited to information such as:

- the use of restraint systems including seat belts by the driver and passengers,
- information about the performance of various systems and modules in the vehicle, and
- information related to engine, throttle, steering, brake or other system status potentially including information related to how the driver operates the vehicle including but not limited to vehicle speed.

This information may be stored during regular operation or in a crash or near crash event. This stored information may be read out and used by:

- service and repair facilities.
- law enforcement or government agencies.
- the Manufacturer and Distributor.

#### **Emission warranty**

The New Vehicle Limited Warranty includes Bumper to Bumper Coverage, Safety Restraint Coverage and Corrosion Coverage. In addition, your vehicle is eligible for Emissions Defect and Emissions Performance Warranties. For a detailed description of what is covered and what is not covered, refer to the *Warranty Guide* that is provided to you along with your *Owner's Guide*.

## Introduction

### Using your vehicle as an ambulance

**WARNING: Do not use this vehicle as an ambulance.**

Your vehicle is not equipped with an ambulance preparation package.

### Using your vehicle with a snowplow























**WARNING: Do not use this vehicle for snowplowing.**

Your vehicle is not equipped with a snowplowing package.

## Introduction

These are some of the symbols you may see on your vehicle.





### Vehicle Symbol Glossary

Safety Alert		See Owner's Guide	
Protecting the Environment		Fasten Safety Belt	
Air Bag-Front		Air Bag-Side	
Passenger Airbag Off		Child Seat	
Child Seat Installation Warning		Child Seat Lower Anchor	
Child Seat Tether Anchor		Brake System	
Anti-Lock Brake System		Brake Fluid - Non-Petroleum Based	
Master Lighting Switch		Hazard Warning Flasher	
Fog Lamps-Front		Fuse Compartment	
Fuel Pump Reset		Windshield Wash/Wipe	
Windshield Defrost/Demist		Rear Window Defrost/Demist	
Power Windows		Power Window Lockout	



## Introduction

### Vehicle Symbol Glossary

Personal Alarm System Feature		Engine Oil	
Engine Coolant		Engine Coolant Temperature	
Do Not Open When Hot		Battery	
Avoid Smoking, Flames, or Sparks		Battery Acid	
Explosive Gas		Fan Warning	
Power Steering Fluid		Maintain Correct Fluid Level	
Emission System		Engine Air Filter	
Powertrain Malfunction		Speed Control	
Passenger Compartment Air Filter		Jack	
Check Fuel Cap		Low Tire Warning	

### INFORMATION ABOUT THIS GUIDE

The information found in this guide was accurate at the time of printing. Mazda may change the contents without notice.

## Instrument Cluster

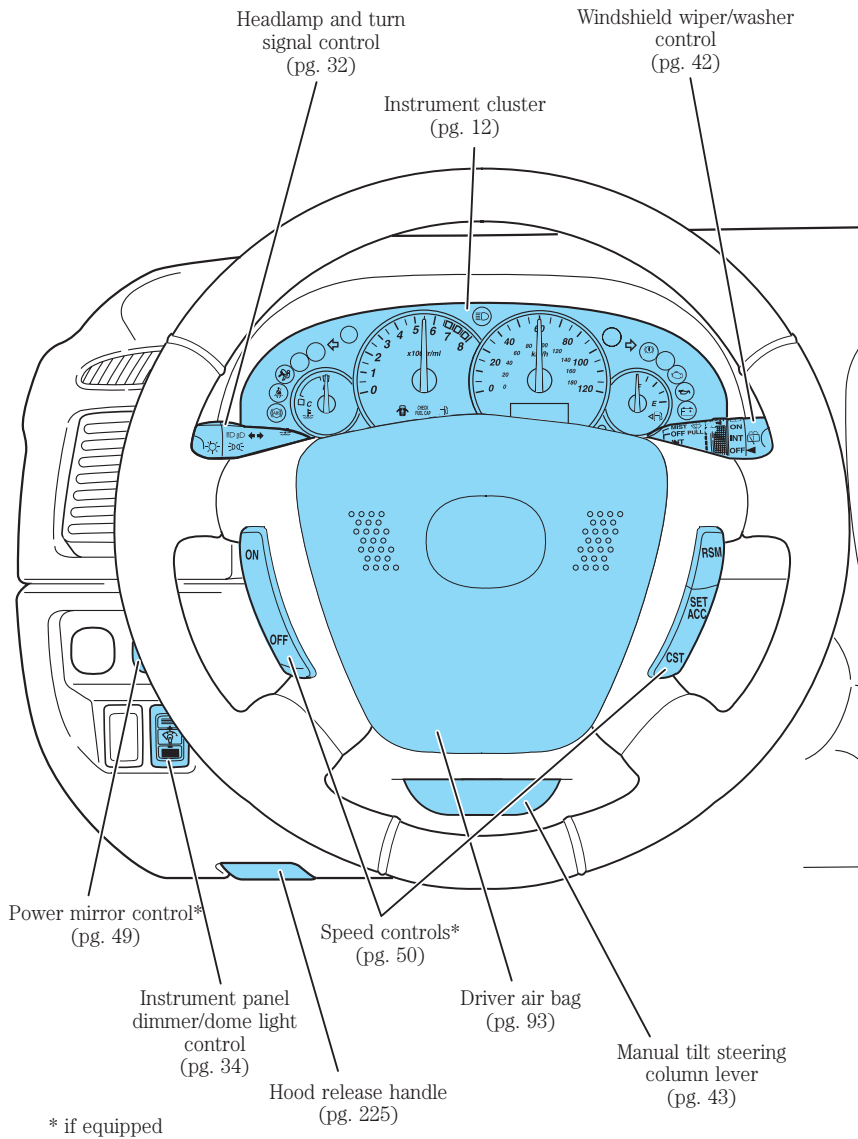

## Instrument Cluster

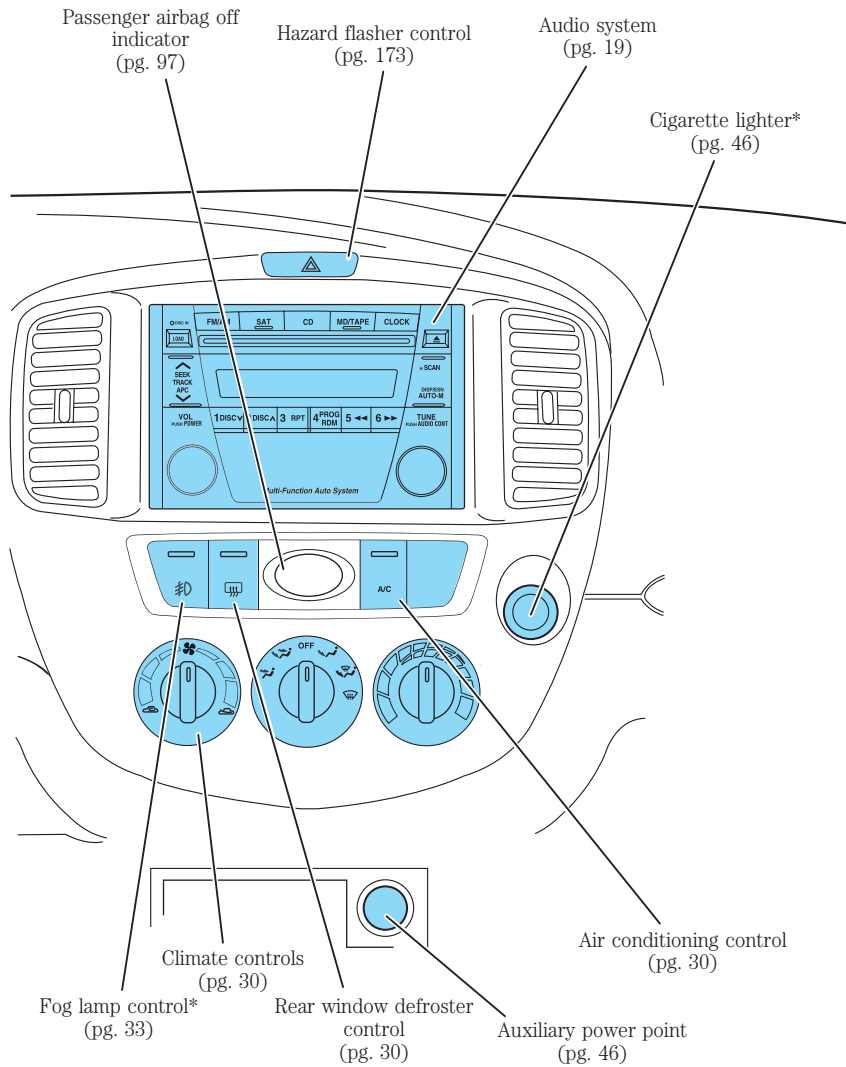

\*if equipped

## Instrument Cluster

### WARNING LIGHTS AND CHIMES

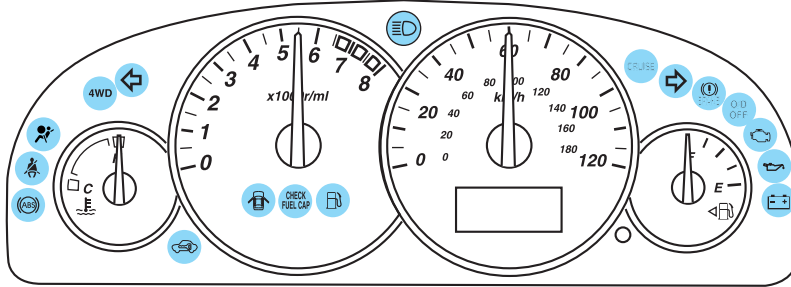

Warning lights and gauges can alert you to a vehicle condition that may become serious enough to cause expensive repairs. A warning light may illuminate when a problem exists with one of your vehicle's functions. Many lights will illuminate when you start your vehicle to make sure the bulb works. If any light remains on after starting the vehicle, have the respective system inspected immediately.

**Service engine soon:** Your vehicle is equipped with a computer that monitors the engine's emission control system. This system is commonly known as the On Board Diagnostics System (OBD II). The OBD II system protects the environment by ensuring that your vehicle continues to meet government emission standards. The OBD II system also assists the service technician in properly servicing your vehicle.

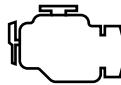

The  indicator light illuminates when the ignition is first turned to the RUN position to check the bulb. If it comes on after the engine is started, one of the engine's emission control systems may be malfunctioning. The light may illuminate without a driveability concern being noted. The vehicle will usually be drivable and will not require towing.

**What you should do if the  light illuminates**

**Light turns on (without blinking):**

This means that the OBD II system has detected a malfunction.

Temporary malfunctions may cause your  light to illuminate. Examples are:

1. The vehicle has run out of fuel. (The engine may misfire or run poorly.)

## Instrument Cluster

2. Poor fuel quality or water in the fuel.
3. The fuel cap may not have been properly installed and securely tightened.

These temporary malfunctions can be corrected by filling the fuel tank with high quality fuel of the recommended octane and/or properly installing and securely tightening the fuel cap. After three driving cycles without these or any other temporary malfunctions present, the  light should turn off. (A driving cycle consists of a cold engine startup followed by mixed city/highway driving.) No additional vehicle service is required.

If the  light remains on, have your vehicle serviced at the first available opportunity.

**Note:** The  light will illuminate if vehicle refueling is conducted with the engine running.

**WARNING: Never refuel vehicle with the engine running.**

### Light is blinking:

Engine misfire is occurring which could damage your catalytic converter. You should drive in a moderate fashion (avoid heavy acceleration and deceleration) and have your vehicle serviced at the first available opportunity.

**WARNING: Under engine misfire conditions, excessive exhaust temperatures could damage the catalytic converter, the fuel system, interior floor coverings or other vehicle components, possibly causing a fire.**

**Check fuel cap:** Momentarily illuminates when the ignition is turned to the ON position to ensure your bulb is working. When the light stays on, check the fuel filler cap. Continuing to operate the vehicle with the check fuel cap light on, can activate the  warning light. When the fuel filler cap is properly re-installed, the light(s) will turn off after a period of normal driving. This period will vary depending on driving conditions.

**CHECK  
FUEL CAP**

## Instrument Cluster

**It may take a long period of time for the system to detect an improperly installed fuel filler cap.**

For more information, refer to *Fuel filler cap* in the *Maintenance and Specifications* chapter.

**Brake system warning light:** To confirm the brake system warning light is functional, it will momentarily illuminate when the ignition is turned to the ON position



when the engine is not running, or in a position between ON and START, or by applying the parking brake when the ignition is turned to the ON position. If the brake system warning light does not illuminate at this time, seek service immediately from an authorized Mazda dealer. Illumination after releasing the parking brake indicates low brake fluid level and the brake system should be inspected immediately by an authorized Mazda dealer.

**WARNING: Driving a vehicle with the brake system warning light on is dangerous. A significant decrease in braking performance may occur. It will take you longer to stop the vehicle. Have the vehicle checked immediately by an authorized Mazda dealer.**

**Anti-lock brake system (ABS):** If the ABS light stays illuminated or continues to flash, a malfunction has been detected, have the system serviced immediately by an

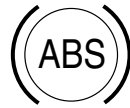

authorized Mazda dealer. Normal braking is still functional unless the brake system warning light also is illuminated.

**WARNING: If the light remains on, continues to flash or fails to illuminate, have the system serviced immediately by an authorized Mazda dealer. With the ABS light on, the anti-lock brake system is disabled but normal braking is still effective unless the brake warning light also remains illuminated with the parking brake released.**

## Instrument Cluster

**Air bag readiness:** If this light fails to illuminate when ignition is turned to ON, continues to flash or remains on, have the system serviced



immediately by an authorized Mazda dealer. A chime will also sound when a malfunction in the supplemental restraint system has been detected.

**Safety belt:** Reminds you to fasten your safety belt. A chime will also sound to remind you to fasten your safety belt.



**Charging system:** Illuminates when the battery is not charging properly.



**Engine oil pressure:** Illuminates when the oil pressure falls below the normal range, refer to *Engine oil* in the *Maintenance and Specifications* chapter.



**Low fuel:** Illuminates when the fuel level in the fuel tank is at or near empty (refer to *Fuel gauge* in this chapter).



**Overdrive off:** Illuminates when the overdrive function of the transmission has been turned off, refer to the *Driving* chapter. **If the light flashes steadily or does not illuminate, have the transmission serviced soon, or damage may occur.**



**Four wheel drive indicator (if equipped):** Illuminates when



ignition is first turned ON to check bulb. Blinking indicator indicates system has been disabled or requires service, refer to the *Driving* chapter.

**Note:** If the light continues to flash, have the system serviced by an authorized Mazda dealer.

## Instrument Cluster

**Anti-theft system:** Flashes when the Securilock™ Passive Anti-theft System has been activated. Refer to *SecuriLock™ passive anti-theft system* in the *Locks and Security* chapter.



**Cruise control/Speed control:**

Illuminates when the cruise control/speed control is activated. Turns off when the cruise control/speed control system is deactivated, refer to the *Driver Controls* chapter.

**CRUISE**

**Door ajar:** Illuminates when the ignition is in the ON position and any door, liftgate, or liftgate window is open.



**Turn signals:** Illuminates when the left or right turn signal or the hazard lights are turned on. If the indicators stay on or flash faster, check for a burned out bulb.



**High beams:** Illuminates when the high beam headlamps are turned on.



**Safety belt warning chime:**  Sounds to remind you to fasten your safety belts.

**Key-in-ignition warning chime:** Sounds when the key is left in the ignition in the OFF/LOCK or ACCESSORY position and the driver's door is opened.

**Headlamps on warning chime:** Sounds when the headlamps or parking lamps are on, the ignition is off (the key is not in the ignition) and the driver's door is opened.



## Instrument Cluster

### GAUGES

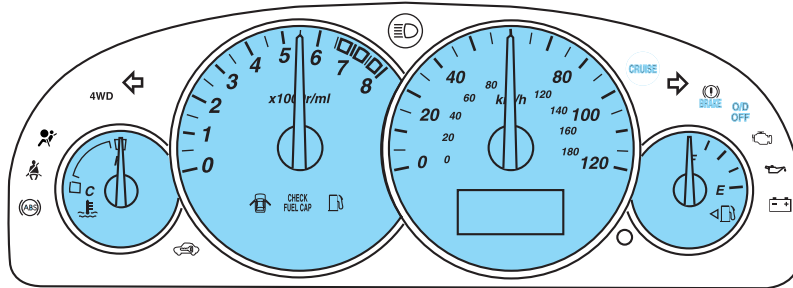

**Speedometer:** Indicates the current vehicle speed.

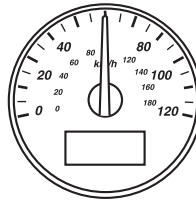

**Engine coolant temperature gauge:** Indicates engine coolant temperature. At normal operating temperature, the needle will be in the normal range (between “H” and “C”). **If it enters the red section, the engine is overheating. Stop the vehicle as soon as safely**

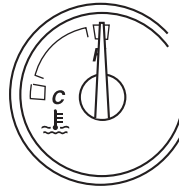

**possible, switch off the engine and let the engine cool.** Refer to *Engine coolant* in the *Maintenance and Specifications* chapter.

**WARNING:** When the engine and radiator are hot, scalding coolant and steam may shoot out under pressure and cause serious injury. Do not remove the cooling system cap when the engine and radiator are hot.

**NOTE:** This gauge indicates the temperature of the engine coolant, not the coolant level. If the coolant is not at its proper level the gauge indication will not be accurate.

## Instrument Cluster

**Odometer:** Registers the total miles (kilometers) of the vehicle.



**Trip odometer:** Registers the miles (kilometers) of individual journeys. Press and hold the button for 1 or more seconds to reset. Press and release the button in less than 1 second to toggle between odometer and trip odometer.



**Tachometer:** Indicates the engine speed in revolutions per minute. Driving with your tachometer pointer continuously at the top of the scale may damage the engine.

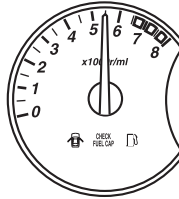

**Fuel gauge:** Displays approximately how much fuel is in the fuel tank. The fuel gauge may vary slightly when the vehicle is in motion or on a grade.

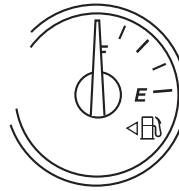

When refueling the vehicle from empty indication, the amount of fuel that can be added will be less than the advertised capacity due to the reserve fuel.

**Note:** The fuel filler door is located on the driver's side of the vehicle.

## Entertainment Systems

### AUDIO SYSTEMS

#### AM/FM Stereo Single CD audio system — Satellite ready capability

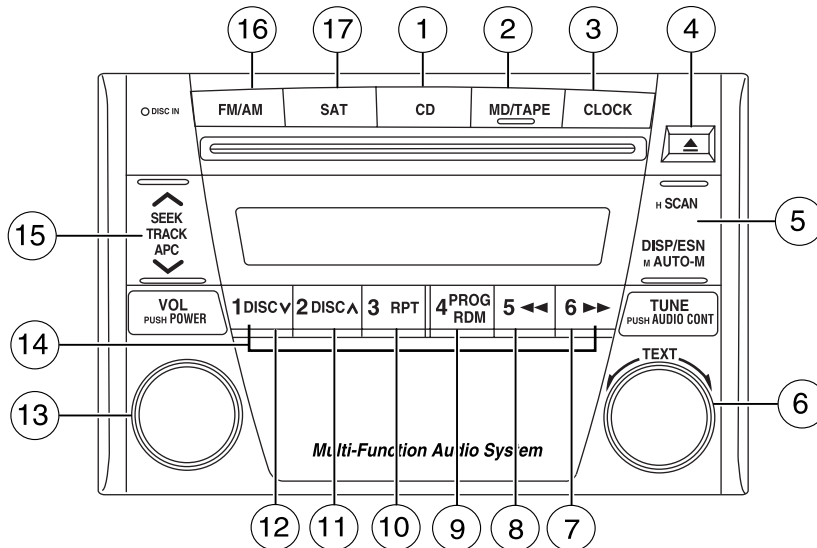

1. **CD:** To begin CD play, insert a CD into the slot, label side up. The system will load the CD and begin play after a short pause. The track number will illuminate in the display.
2. **MD/TAPE:** This control does not function on the base audio system. It will function with a tape or mini disc (MD) upgrade.
3. **CLOCK:** Press and release CLOCK to alternate between the time and the audio display. The clock can be set at any time when the ignition switch is in the ACC or ON position.

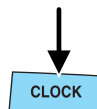
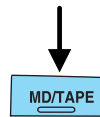
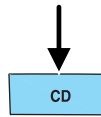

## Entertainment Systems

Press and hold **CLOCK** for approximately two seconds until a beep sound is heard. The clock's current time will flash. Press **SCAN** adjust the hours. Press **AUTO-M** to adjust the minutes. Press **CLOCK** again to start the clock.

**NOTE:** If the audio operation is selected while the clock mode is on, the selected audio mode will be displayed for ten seconds, then the display will revert to the clock mode.

**NOTE:** If the power supply to the unit is interrupted (if the fuse blows or the vehicle's battery is disconnected), the clock will need to be reset.

**NOTE:** If the time is not adjusted while the clock's current time is flashing (if neither H nor M is pressed), and the clock control is pressed a second time, the minutes will be set to 00. If the clock's current time setting is within the latter part of the hour (from 30 to 59 min), the hour setting will automatically advance one hour.

4. **Eject:** Press to eject the CD.



5. **SCAN/DISP/ESN/AUTO-M**

**SCAN:** Press in radio or CD mode for a brief sampling of all listenable stations or of each CD track. Press again to disable scan mode. If the unit is left in scan mode, normal play will resume where scan was selected.



**DISP/ESN:** Your radio comes equipped with Satellite ready capability. This enables you to view the song titles, artist, and further information. The kit to enable Satellite reception is available through your dealer. Detailed Satellite and instructions are included with the dealer installed kit.

**AUTO-M:** Auto memory tuning allows you to set strong radio stations without losing your original manually set preset stations. This feature is helpful on trips when you travel between cities with different radio stations.

Press the FM/AM control to select a frequency. Press and momentarily hold the **AUTO-M** (Auto memory) control. The system will beep. Press the **AUTO-M** (Auto memory) control to select from the stored stations. One stored station will be selected and played each time the control is pressed. The frequency and channel number will be displayed.

## Entertainment Systems

**NOTE:** If no stations can be tuned after scanning operations, A will appear in the display.

**NOTE:** If the power supply is interrupted, (fuse blows or the battery is disconnected), the preset channels will be canceled.

6. **TUNE:** The TUNE control is a multi-functional control which works in radio and CD modes to adjust the levels of bass, treble, balance, fade, mid-range and beep (off/on). Press to select the desired function. Turn to adjust the desired levels. TUNE also works in radio mode to manually increase or decrease the frequency.



7. **Fast forward:** In CD mode, press and hold to advance through a track at a high speed.



8. **Rewind:** In CD mode, press and hold to reverse through a track at a high speed.



9. **PROG/RDM:** Press during CD play for a random selection of songs. Press again to disengage random play.



10. **RPT:** Press during CD play to listen to a selection repeatedly. RPT will illuminate in the display and the current selection will be repeated. Press again to disengage repeat play.



## Entertainment Systems

11. **DISC**  : Press to skip forward to the beginning of the next CD.



12. **DISC**  : Press to skip back to the beginning of the previous CD.

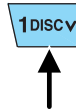

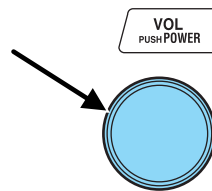

13. **Volume/ON/OFF**: Press to turn the system on/off. Turn to adjust the volume.



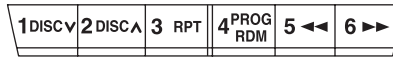

14. **Memory presets**: Your audio is equipped with six station memory preset controls. These controls can be used to select up to six preset AM stations and 12 FM stations (six in FM1 and six in FM2).  
Select a frequency with the AM/FM.

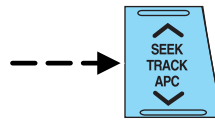

15. **SEEK/TRACK/APC**: **SEEK** works in radio mode and allows you to advance to all listenable radio stations up () or down () the radio frequency.



**Note:** If you continue to press and hold the control, the frequency will continue changing without stopping. Release the control after a beep sounds.

**TRACK:** Works in CD mode and allows you to skip forward to the beginning of the next track () or back to the beginning of the current track () .

**APC (Auto program control):** This feature works in tape mode and is not operational on this system.

## Entertainment Systems

16. **FM/AM:** Press to enter radio mode and select a frequency from FM1, FM2 or AM.
17. **SAT:** Your radio comes equipped with Satellite ready capability. This enables you to view the song titles, artist, and further information. The kit to enable Satellite reception is available through your dealer. Detailed Satellite instructions are included with the dealer installed kit.

### AM/FM Stereo Six CD audio system — Satellite ready capability (if equipped)

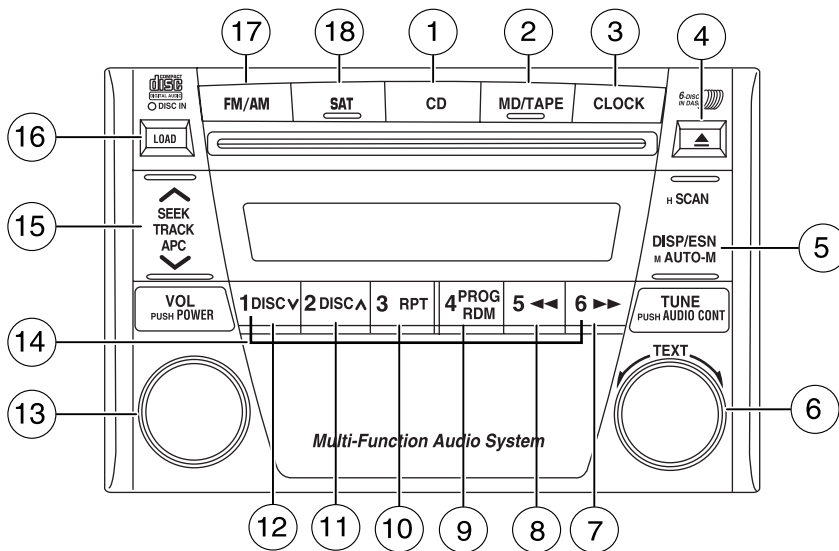

1. **CD:** To begin CD play, insert a CD into the slot, label side up. The system will load the CD and begin play after a short pause. The disc and track number will illuminate in the display.

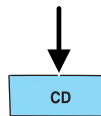

## Entertainment Systems

2. **MD/TAPE:** This control does not function on this audio system. It will function with a cassette or mini disc (MD) upgrade.

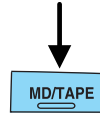

3. **CLOCK:** Press and release CLOCK to alternate between the time and the audio display. The clock can be set at any time when the ignition switch is in the ACC or ON position.

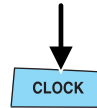

Press and hold CLOCK for approximately two seconds until a beep sound is heard. The clock's current time will flash. Press SCAN adjust the hours. Press AUTO-M to adjust the minutes. Press CLOCK again to start the clock.

**NOTE:** If the audio operation is selected while the clock mode is on, the selected audio mode will be displayed for ten seconds, then the display will revert to the clock mode.

**NOTE:** If the power supply to the unit is interrupted (if the fuse blows or the vehicle's battery is disconnected), the clock will need to be reset.

**NOTE:** If the time is not adjusted while the clock's current time is flashing (if neither H nor M is pressed), and the clock control is pressed a second time, the minutes will be set to 00. If the clock's current time setting is within the latter part of the hour (from 30 to 59 min.), the hour setting will automatically advance one hour.

4. **Eject:** Press to eject the CD.



5. **SCAN/DISP/ESN/AUTO-M**

**SCAN:** Press in radio or CD mode for a brief sampling of all listenable stations or of each CD track. Press again to disable scan mode. If the unit is left in scan mode, normal play will resume where scan was selected.

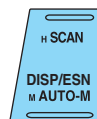



## Entertainment Systems

**DISP/ESN:** Your radio comes equipped with Satellite ready capability. This enables you to view the song titles, artist, and further information. The kit to enable Satellite reception is available through your dealer. Detailed Satellite and instructions are included with the dealer installed kit.

**AUTO-M:** Press the FM/AM control to select auto memory tuning which allows you to set strong radio stations without losing your original manually set preset stations. This feature is helpful on trips when you travel between cities with different radio stations.

Press the FM/AM control to select a frequency. Press and momentarily hold the AUTO-M (Auto memory) control. The system will beep. Press the AUTO-M (Auto memory) control to select from the stored stations. One stored station will be selected and played each time the control is pressed. The frequency and channel number will be displayed.

**NOTE:** If no stations can be tuned after scanning operations, A will appear in the display.

**NOTE:** If the power supply is interrupted, (fuse blows or the battery is disconnected), the preset channels will be canceled.

6. **TUNE:** The TUNE control is a multi-functional control which works in radio and CD modes to adjust the levels of bass, treble, balance, fade, mid-range and beep (off/on). Press to select the desired function. Turn to adjust the desired levels. TUNE also works in radio mode to manually increase or decrease the frequency.



7. **Fast forward:** In CD mode, press and hold to advance through a track at a high speed.



8. **Rewind:** In CD mode, press and hold to reverse through a track at a high speed.



## Entertainment Systems

9. **PROG/RDM:** Press during CD play for a random selection of songs. Press again to disengage random play. RDM will illuminate in the display.
10. **RPT:** Press during CD play to listen to a selection repeatedly. RPT will illuminate in the display and the current selection will be repeated. Press again to disengage repeat play.
11. **DISC ▲:** Press to skip forward to the beginning of the next CD.
12. **DISC ▼:** Press to skip back to the beginning of the previous CD.
13. **Volume/ON/OFF:** Press to turn the system on/off. Turn to adjust the volume.

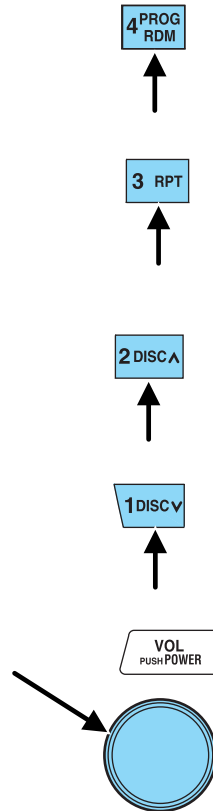

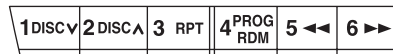

14. **Memory presets:** Your audio is equipped with six station memory preset controls. These controls can be used to select up to six preset AM stations and 12 FM stations (six in FM1 and six in FM2). Select a frequency with the AM/FM.





## Entertainment Systems

15. **SEEK/TRACK/APC: SEEK**

works in radio mode and allows you to advance to all listenable radio stations up  or down  the radio frequency.

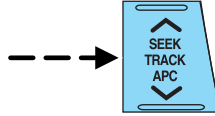
**Note:** If you continue to press and hold the control, the frequency will continue changing without stopping. Release the control after a beep sounds.



**TRACK:** Works in CD mode and allows you to skip forward to the beginning of the next track () or back to the beginning of the current track () .

**APC (Auto program control):** Works in tape mode and is not operational on this system.

16. **LOAD:** Press to load a CD.

Press LOAD and a memory preset to load a CD into a specific slot. Press and hold LOAD to enter up to six CDs one at a time.

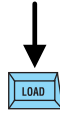

17. **FM/AM:** Press to enter radio mode and select a frequency from AM/FM1/FM2.

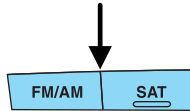

18. **SAT:** Your radio comes equipped with Satellite ready capability. This enables you to view the song titles, artist, and further information. The kit to enable Satellite reception is available through your dealer. Detailed Satellite instructions are included with the dealer installed kit.

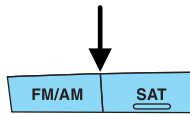

## Entertainment Systems

### GENERAL AUDIO INFORMATION

#### Radio frequencies:

AM and FM frequencies are established by the Federal Communications Commission (FCC) and the Canadian Radio and Telecommunications Commission (CRTC). Those frequencies are:

AM - 530, 540–1700, 1710 kHz

FM- 87.7, 87.9–107.7, 107.9 MHz

#### Radio reception factors:

There are three factors that can affect radio reception:

- Distance/strength: The further you travel from an FM station, the weaker the signal and the weaker the reception.
- Terrain: Hills, mountains, tall buildings, power lines, electric fences, traffic lights and thunderstorms can interfere with your reception.
- Station overload: When you pass a broadcast tower, a stronger signal may overtake a weaker one and play while the weak station frequency is displayed.

#### Cassette/player care:

##### Do:

- Use only cassettes that are 90 minutes long or less.
- Tighten very loose tapes by inserting a finger or pencil into the hole and turning the hub.
- Remove loose labels before inserting tapes.
- Allow tapes which have been subjected to extreme heat, humidity or cold to reach a moderate temperature before playing.
- Clean the cassette player head with a cassette cleaning cartridge after 10–12 hours of play to maintain good sound/operation.

##### Don't:

- Expose tapes to direct sunlight, extreme humidity, heat or cold.
- Leave tapes in the cassette player for a long time when not being played.

## Entertainment Systems

### CD/CD player care:

#### Do:

- Handle discs by their edges only. Never touch the playing surface.
- Inspect discs before playing. Clean only with an approved CD cleaner and wipe from the center out.

#### Don't:

- Expose discs to direct sunlight or heat sources for extended periods of time.
- Insert more than one disc into each slot of the CD changer magazine.
- Clean using a circular motion.

**CD units are designed to play commercially pressed 12 cm (4.75 in) audio compact discs only. Due to technical incompatibility, certain recordable and re-recordable compact discs may not function correctly when used in Mazda CD players. Irregular shaped CDs, CDs with a scratch protection film attached, and CDs with homemade paper (adhesive) labels should not be inserted into the CD player. The label may peel and cause the CD to become jammed. It is recommended that homemade CDs be identified with permanent felt tip marker rather than adhesive labels. Ball point pens may damage CDs. Please contact your dealer for further information.**

### Audio system warranty and service:

Refer to the *Warranty Guide* for audio system warranty information. If service is necessary, see your authorized Mazda dealership.

## Climate Controls

### MANUAL HEATING AND AIR CONDITIONING SYSTEM

1. **A/C:** Press to activate A/C. The indicator light will illuminate to indicate A/C is functioning.
2. **Temperature selection:** Controls the temperature of the airflow in the vehicle.
3. **Air flow selections:** Controls the direction of the airflow in the vehicle. See the following for a brief description on each control.

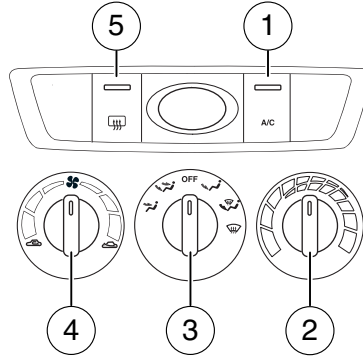

 : Distributes air through the instrument panel vents.

 : Distributes air through the instrument panel vents and the floor vents.

**OFF:** The fan will not operate.

 : Distributes air through the floor vents.

 : Distributes air through the windshield defroster vents and floor vents.

 : Distributes air through the windshield defroster vents.



4. **Fan speed and recirculated/outside air control:** Turned to the right, controls the volume of outside air coming into the vehicle. Turned to the left, recirculates air through the instrument panel registers. This mode is more economical and efficient. May reduce undesirable odors from entering the vehicle.
5. **Rear defroster:** Press to clear the rear window of thin ice and fog. The indicator light will illuminate when the rear defroster is activated. Ensure that the ignition is in the 3 (RUN) position to operate. The defroster turns off automatically after 15 minutes or when the ignition is turned to the 1 (LOCK) position. To manually turn off the defroster before 15 minutes have passed, push the control again.

**WARNING: Extended operation of the climate control system in a recirculated air mode may lead to a reduction in air quality in the cabin. The air in the cabin should be periodically refreshed by selecting settings other than recirculated air.**

## Climate Controls

**WARNING: Under some weather conditions, use of the recirculated air mode may lead to glass misting or fogging. Switch the air conditioner on and select the fresh air mode. Heated air can assist windscreen demisting.**

### Operating tips

- To reduce fog build up on the windshield during humid weather, place the air flow selector in the  position.
- To reduce humidity build up inside the vehicle: do not drive with the air flow selector in the OFF position or place the fan control in the recirculated air positions.
- The A/C system will be activated automatically when switching the air flow selector in the  or  position.
- Under normal weather conditions, do not leave the air flow selector in OFF when the vehicle is parked. This allows the vehicle to “breathe” using the outside air inlet vents.
- Do not put objects under the front seats that will interfere with the airflow to the back seats.
- Remove any snow, ice or leaves from the air intake area at the base of the windshield.

To aid in side window defogging/demisting in cold weather:

1. Select A/C.
2. Adjust the temperature control to maintain comfort.
3. Set the fan speed to the highest setting on the right for outside air.
4. Direct the outer instrument panel vents towards the side windows.

To increase airflow to the outer instrument panel vents, close the vents located in the middle of the instrument panel.

**WARNING: Do not place objects on top of the instrument panel as these objects may become projectiles in a collision or sudden stop.**

## Lights

### HEADLAMP CONTROL ☀️

OFF Turns the lamps off.

☀️ Turns on the parking lamps, instrument panel lamps, license plate lamps and tail lamps.

☀️ Turns the headlamps on.

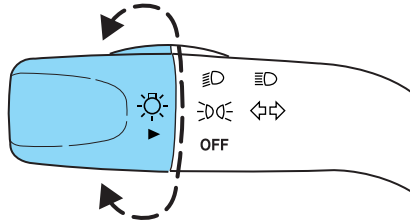

### BATTERY SAVER

Your vehicle is equipped with a battery saver feature which, if you leave the headlamps on, automatically turns off the headlamps after 30 seconds when the ignition is in the OFF position.

### High beams ☀️

After turning the headlamps on, push the lever toward the instrument panel to activate. Pull the lever towards you to deactivate.

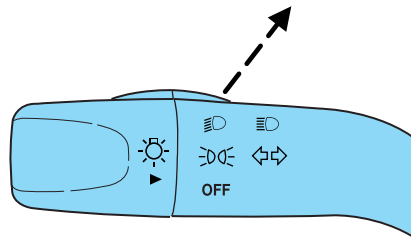

### Flash to pass

Pull toward you slightly to activate and release to deactivate.

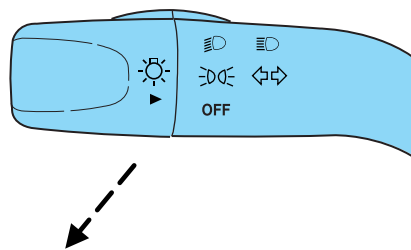



## Lights

### Daytime running lamps (DRL) (if equipped)

Turns the headlamps on with a reduced output.

To activate:

- the ignition must be in the ON position,
- the headlamp control is in the OFF or parking lamp position and
- the parking brake must be disengaged.

**WARNING: Always remember to turn on your headlamps at dusk or during inclement weather. The Daytime Running Lamp (DRL) system does not activate the tail lamps and generally may not provide adequate lighting during these conditions. Failure to activate your headlamps under these conditions may result in a collision.**

### FOG LAMP CONTROL (IF EQUIPPED)

The foglamps can only be turned on when:

- the headlamp control is in the low beam or parking lamp position, and
- the ignition key is in the ON position.

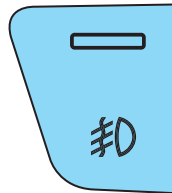

When the ignition is in the OFF position, the fog lamp is deactivated, even when the headlamp control is in the parking lamp or low beam position.

When the highbeams are activated, the fog lamps will not operate.

Press the fog lamp control again to deactivate the fog lamps.

## Lights

### INSTRUMENT PANEL DIMMER CONTROL

Use to adjust the brightness of the instrument panel.

- Push and hold top of control to brighten.

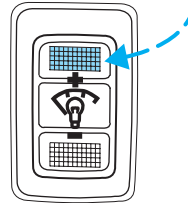

- Push and hold bottom of control to dim.

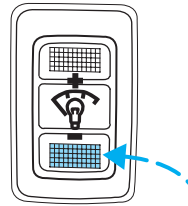

### VERTICAL AIM ADJUSTMENT

1. Park the vehicle directly in front of a wall or screen on a level surface, approximately 25 feet (7.6 meters) away.

- (1) 8 feet (2.4 meter)
- (2) Center height of lamp to ground
- (3) 25 feet (7.6 meters)
- (4) Horizontal reference line

2. Measure the height from the center of your headlamp to the ground and mark an 8 foot (2.4 meter) horizontal reference line on the vertical wall or screen at this height (a piece of masking tape works well). The center of the lamp is marked by a 3.0 mm circle on the headlamp lens.

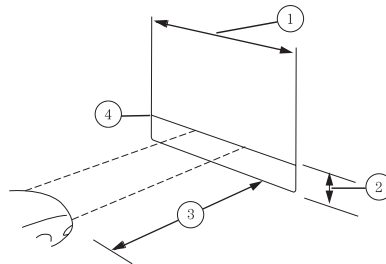

3. Turn on the low beam headlamps to illuminate the wall or screen and open the hood. Cover the left-hand headlamp with an opaque cloth.

## Lights

4. On the wall or screen you will observe a light pattern with a distinct horizontal edge of high intensity light towards the right. If this edge is not at the horizontal reference line, the beam will need to be adjusted.

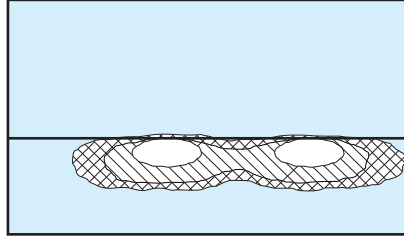

5. Locate the vertical adjuster on the headlamp, then use a 7 mm hex socket or T20 Torx driver to turn the adjuster either counterclockwise (to adjust down) or clockwise (to adjust up) aligning the upper edge of the light pattern up to the horizontal line. Aftermarket photometric aimers are not recommended for use on Mazda vehicles.

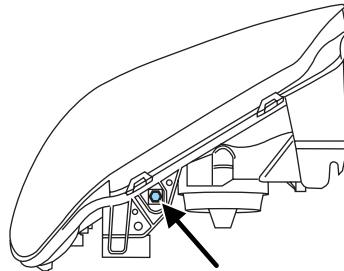

6. Move the opaque cloth to cover the right-hand headlamp and repeat Steps 4 and 5 for the left-hand headlamp.
7. Close the hood and turn off the lamps.

HORIZONTAL AIM IS NOT REQUIRED FOR THIS VEHICLE AND IS NON-ADJUSTABLE.

### TURN SIGNAL CONTROL ⇄

- Push down to activate the left turn signal.
- Push up to activate the right turn signal.

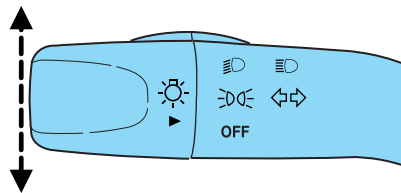

## Lights

### INTERIOR LAMPS

#### Cargo and dome lamp

Rear cargo lamp equipped with an ON/OFF/DOOR control will light when:

- the doors are closed and the control is in the ON position.
- the control is in the DOOR position and any door is open.

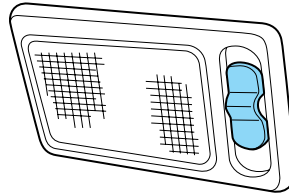

When the control is in the OFF position, it will not illuminate when you open the doors.

#### Dome lamps and map lamps

The front dome lamp is located overhead between the driver and passenger seats.

The dome lamp control has three positions:

- OFF: In this position, the lamp will not illuminate.
- DOOR: In this position, the dome lamp will illuminate only when a door is opened and will remain illuminated for 25 seconds after the door is shut.
- ON: In this position, the lamp will remain illuminated.

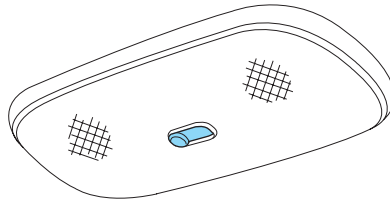

The map lamp controls (without moon roof) are located on the dome lamp. Press the button on either side of each map lamp to illuminate the lamps. Push the button again to turn off the lamps.

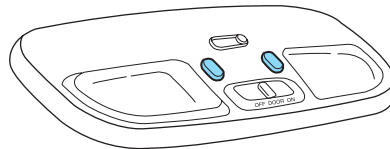

## Lights

For models equipped with a moon roof, the map lamps are located on the moon roof control panel. Press the button on either side of each map lamp to illuminate the lamps. Push the button again to turn off the lamps.

The map lamps will illuminate whenever a door is opened. After the door is shut, the lamps will remain illuminated for 25 seconds.

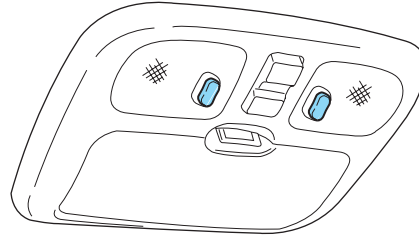

### BULB REPLACEMENT

#### Replacing exterior bulbs

Check the operation of all the bulbs frequently.

#### Replacing the interior bulbs

Check the operation of the following interior bulbs frequently:

- interior overhead lamp
- map lamp

For bulb replacement, see an authorized Mazda dealer.

#### Using the right bulbs

Replacement bulbs are specified in the chart below. Headlamp bulbs must be marked with an authorized "D.O.T." for North America to assure lamp performance, light brightness and pattern and safe visibility.

**Note:** The correct bulbs will not damage the lamp assembly or void the lamp assembly warranty and will provide quality bulb burn time.

Function	Number of bulbs	Trade number
Park/turn lamps (front)	2	3157 AK (amber)
Headlamps	2	9003 (HB2)
Rear stop/tail lamps	2	W21/5W
Rear turn lamps	2	WY21W (amber)
Rear license plate lamps	2	W5W
Backup lamp	2	W21W

## Lights

Function	Number of bulbs	Trade number
Side repeater lamp	2	WY5W (amber)
Fog lamp (if equipped)	2	H1
Cargo lamp	1	211-2
Center high-mount stop lamp	5	W5W
Interior overhead lamp	1	912 (906)
Map lamps	2	168 (T10)
All replacement bulbs are clear in color except where noted.		
To replace all instrument panel lights - see your authorized Mazda dealer.		

### Replacing headlamp bulbs

**NOTE:** This procedure can be difficult. Your Mazda dealer has the proper tools, training and parts to perform this task. If you have difficulty with this procedure, visit your local Mazda dealer.

**WARNING:** Handle a halogen headlamp bulb carefully and keep out of children's reach. Grasp the bulb only by its metal base and do not touch the glass. The oil from your hand could cause the bulb to break the next time the headlamps are operated. Always wear safety glasses when handling halogen bulbs.

1. Make sure that the headlamp control is in the OFF position.
2. Open the hood.
3. Disconnect the electrical connector from the bulb by pulling rearward.

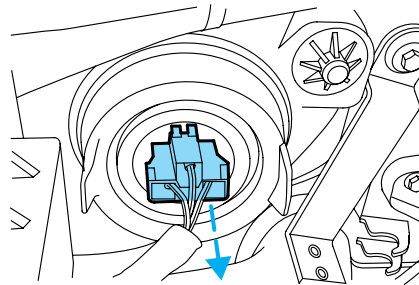

## Lights

4. Remove the rubber boot from the lamp assembly by pulling on one of the tabs.

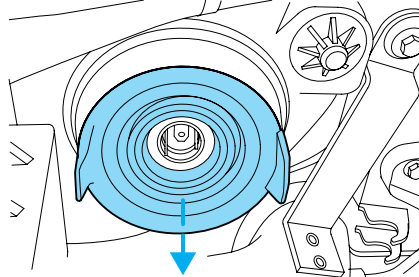

5. Squeeze the retainer spring together releasing it from bulb hooks and rotate it away from the bulb.

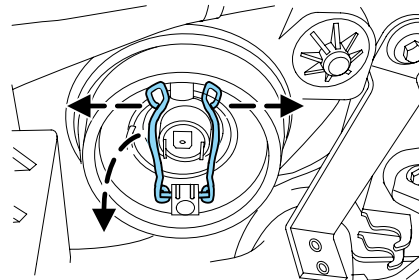

6. Without turning, carefully pull bulb out of headlamp assembly.

**Note:** The bulb's metal base gets very hot during headlamp operation. Be sure the bulb base is cool before handling.

*If the bulb is accidentally touched, it should be cleaned with rubbing alcohol before being used.*

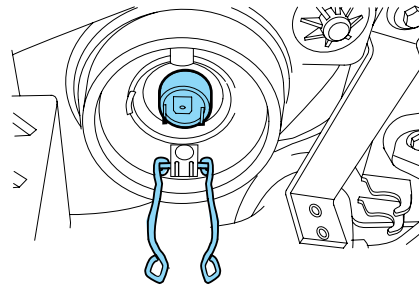

7. Insert the glass end of the new bulb into the headlamp assembly. When the bulb's three metal tabs are aligned with the grooves in the plastic base, push the bulb into the lamp assembly until the bulb's metal base contacts the plastic base.
8. Rotate the retainer spring over the bulb's metal base and secure it on the bulb hooks.
9. Install rubber boot on the lamp assembly. Be sure to press firmly around the perimeter of the boot and around the bulb to ensure the proper seal of the bulb.
10. Connect the electrical connector into the rear of the bulb until it "snaps."

## Lights

### **Replacing front parking lamp/turn signal bulbs**

For bulb replacement, see your authorized Mazda dealership.

### **Replacing side repeater bulbs**

1. Turn the headlamp switch to off.
2. Carefully pry the lamp assembly away from the fender.
3. Rotate the bulb socket counterclockwise to remove it from the lamp assembly.
4. Pull the bulb straight out.

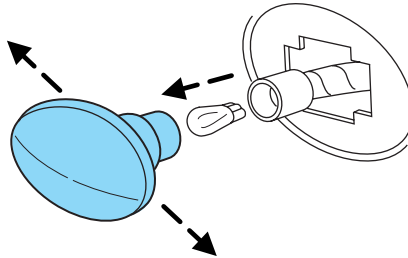

Reverse steps to reinstall bulb(s).

### **Replacing foglamp bulbs**

For bulb replacement, see your authorized Mazda dealership.

### **Replacing brake/tail/turn/backup lamps bulbs**

The brake/tail/turn/backup lamp bulbs are located in the tail lamp assembly, one just below the other. Follow the same steps to replace either bulb:

1. Open the liftgate to expose the lamp assemblies.
2. Remove the two screws from the lamp assembly.
3. Carefully remove the lamp assembly by pulling it rearward.
4. Twist the bulb socket counterclockwise and remove from lamp assembly.
5. Pull the bulb straight out of the socket and push in the new bulb.
6. To complete installation, follow the removal procedure in reverse order.

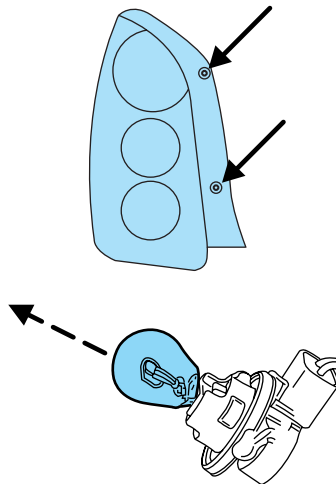



### Replacing license plate lamp bulbs

1. Push the license plate lamp assembly to the right and remove the assembly (located above the license plate) from the liftgate.
2. Remove bulb socket from lamp assembly by turning counterclockwise.
3. Pull the bulb out from the socket and push in the new bulb.
4. Install the bulb socket in lamp assembly and turn it clockwise.
5. Install the lamp assembly on liftgate.

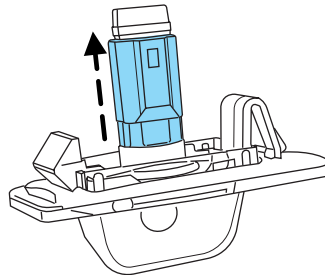

### Replacing high-mount brake lamp bulbs

To remove the lamp assembly:

1. Remove the two screws and move the lamp assembly away from the liftgate.
2. Remove the bulb holder from the lamp assembly by depressing the snaps.

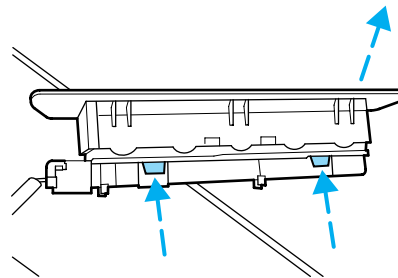
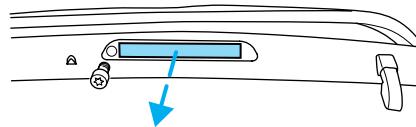

3. Pull the bulb straight out of the socket and push in the new bulb.

To complete installation, follow the removal procedure in reverse order.

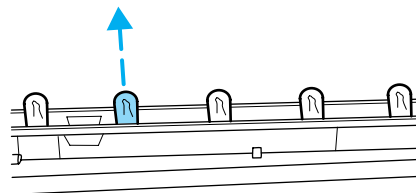

## Driver Controls

### MULTI-FUNCTION LEVER

**Windshield wiper:** For intermittent operation, move control down one position.

Adjust the rotary control to the desired speed setting.

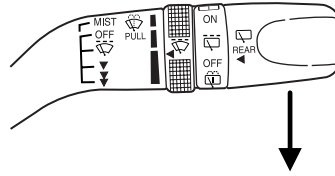

For normal or low speed wiper operation, move control down two positions from OFF.

For high speed wiper operation, move control down three positions from OFF.

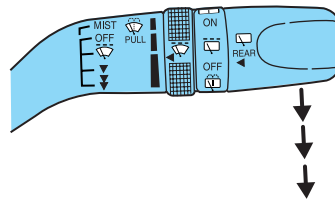

**Mist function:** To activate mist, push control up from the OFF position and release to get one wipe.

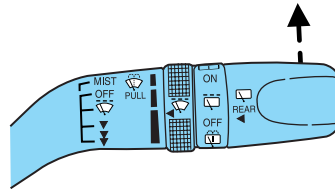

**Windshield washer:** To activate the windshield washer, pull control toward you. Release control to stop washer fluid spray.

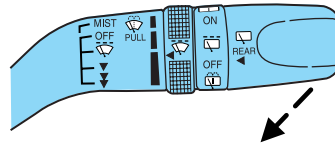

## Driver Controls

### Rear window wiper/washer controls

For intermittent operation of rear wiper, rotate end of control upward to the  position.

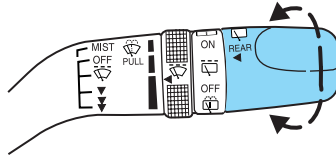

For normal speed rear wiper operation, rotate control upward to ON.

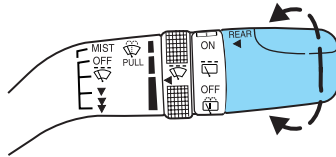

To activate the rear washer, rotate the control to the  position and release.

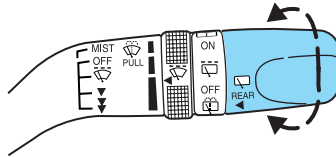

### MANUAL TILT STEERING COLUMN

To adjust the steering wheel:

1. Pull down and hold the steering wheel release control.
2. Move the steering wheel up or down until you find the desired location.
3. Pull the steering wheel release control up. This will lock the steering wheel in position.

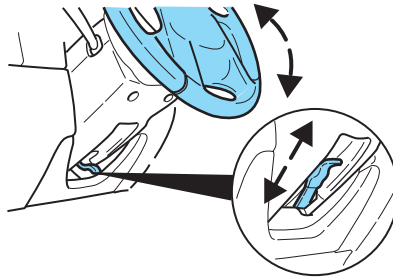

**WARNING: Adjusting the steering wheel while the vehicle is moving is dangerous. Moving it can very easily cause the driver to abruptly turn to the left or right. This can lead to loss of control or an accident. Never adjust the steering wheel while the vehicle is moving.**

## Driver Controls

### OVERHEAD CONSOLE (IF EQUIPPED)

The appearance of your vehicle's overhead console will vary according to your option package.

### Storage compartment (if equipped)

Press the OPEN control to open the storage compartment. The door will open slightly and can be moved to full open.

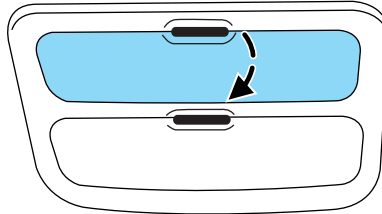

### Installing a garage door opener (if equipped)

The storage compartment can be converted to accommodate a variety of aftermarket garage door openers:

- Remove the VELCRO® pad (2) from the storage compartment door (3).
- Place VELCRO® (5) on aftermarket transmitter (6) opposite of actuator control (8).
- Measure the thickness (4) of the aftermarket transmitter (6).
- Remove the rubber actuator (1) from the storage compartment (7) by pulling the rubber actuator (1) forward and twisting at the same time.

**Note: The length of the rubber actuator (1) is critical.** Use care in cutting it to length. If the rubber actuator (1) is cut too much the aftermarket transmitter (6) will not activate the garage door opener. If

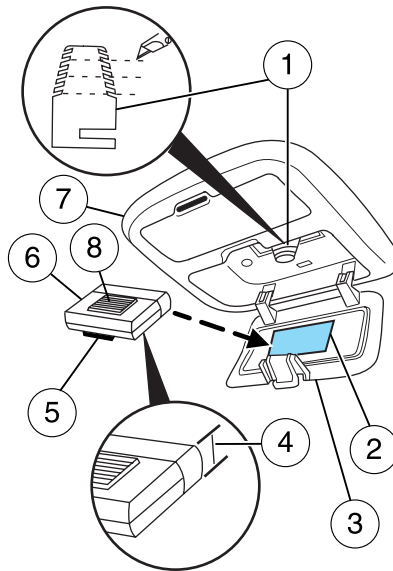

## Driver Controls

the rubber actuator (1) is cut too long, the storage compartment door (3) will not close properly. Excessive force to close the storage compartment door (3) may cause the door latch to break.

- Per the table below, cut the rubber actuator (1) to the proper length based on the thickness (4) measured in the third step.

Approximate <b>Thickness of Transmitter</b> (GDO)		
inches	mm	<b>Cut to Bottom of Notch</b>
<b>Less Than</b>		
1/4	6.35	No Cut
7/8	22.00	Notch 2
1.0	26.00	Notch 4
1-3/16	32.00	Notch 6

- Reinstall the rubber actuator (1) in the storage compartment (7) by twisting and pushing it back into the slot.
- Install the transmitter (6) on to storage compartment door (3) aligning the actuator control (8) with the rubber actuator (1). Close the storage compartment door (3) to verify proper fit. Do not force the storage compartment door (3) or you may break the door latch. If the rubber actuator (1) is the proper length the storage compartment door will close. Press the storage compartment door (3) to activate the transmitter (6).

### **Illuminated visor mirror (if equipped)**

Lift the mirror cover to turn on the visor mirror lamps.

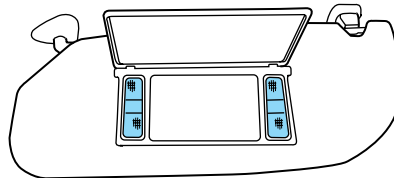

## Driver Controls

### AUXILIARY POWER POINT (12VDC)

**WARNING: Power outlets are designed for accessory plugs only. Do not insert any other object in the power outlet as this will damage the outlet and blow the fuse. Do not hang any type of accessory or accessory bracket from the plug. Improper use of the power outlet can cause damage not covered by your warranty.**

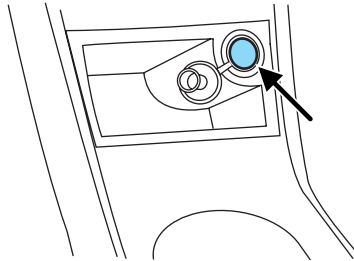

The auxiliary power point is located on the center console in front of the gearshift.

Do not use the power point for operating the cigarette lighter element (if equipped).

To prevent the fuse from being blown, do not use the power point(s) over the vehicle capacity of 12 VDC/180W.

To prevent the battery from being discharged, do not use the power point longer than necessary when the engine is not running.

#### **Cigarette/Cigar lighter (if equipped)**

Do not plug optional electrical accessories into the cigarette lighter socket.

Do not hold the lighter in with your hand while it is heating, this will damage the lighter element and socket. The lighter will be released from its heating position when it is ready to be used.

Improper use of the lighter can cause damage not covered by your warranty.

## Driver Controls

### CENTER CONSOLE

Your vehicle is equipped with a variety of console features. These include:

1. Power point
2. Cupholders
3. Utility compartment
4. Ash cup (if equipped)

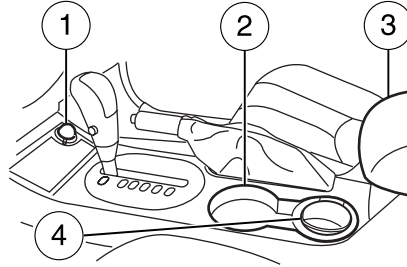

**WARNING: Use only soft cups in the cupholder. Hard objects can injure you in a collision.**

### POWER WINDOWS

**WARNING: Do not leave children unattended in the vehicle and do not let children play with the power windows. They may seriously injure themselves.**

**WARNING: When closing the power windows, you should verify they are free of obstructions and ensure that children and/or pets are not in the proximity of the window openings.**

The ignition must be in the ON position to adjust the power windows. Press and hold the bottom part of the rocker switch to open the window. Press and hold the top part of the rocker switch to close the window.

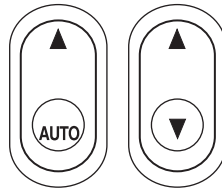

## Driver Controls

### One touch down

Allows the driver's window to open fully without holding the control down. Press completely down on AUTO and release quickly. Press again to stop.

**Note:** This feature will only operate the driver's side window.

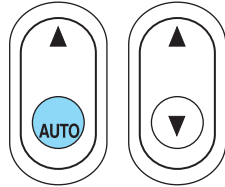

### Window lock

The window lock feature disables all the power windows except the driver's.

To lock out all the window controls except for the driver's window press the right side of the control.

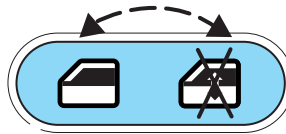

**Note:** The window switches will not illuminate when the window control is in the LOCKED position.

Press the left side to restore the window controls.

### Accessory delay

With accessory delay, power windows and moonroof operate for up to ten minutes after the ignition switch is turned from the ACC or ON to the OFF position, the key is not in the ignition or until any door is opened.

**WARNING: Do not leave children unattended in the vehicle and do not let children play with the power windows or moon roof. They may seriously injure themselves.**



## Driver Controls

### MIRRORS

#### Power side view mirrors

To adjust your mirrors:

1. Rotate the control, located on the instrument panel left of the steering wheel, clockwise to adjust the right mirror and rotate the control counterclockwise to adjust the left mirror.
2. Move the control in the direction you wish to tilt the mirror.
3. Return to the center position to lock mirrors in place.

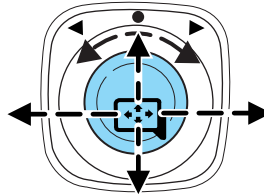

#### Fold-away mirrors

Carefully pull the outside mirrors inwards when driving through a narrow space, like an automatic car wash.

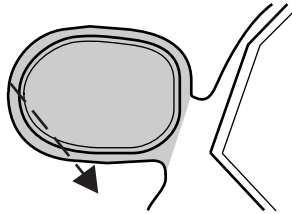

#### Heated outside mirrors (if equipped)

Both mirrors are heated automatically to remove ice, mist and fog when the rear window defrost is activated.

**Do not remove ice from the mirrors with a scraper or attempt to readjust the mirror glass if it is frozen in place.**

**These actions could cause damage to the glass and mirrors.**

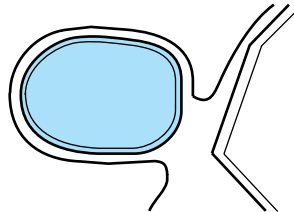

## Driver Controls

### CRUISE CONTROL/SPEED CONTROL (IF EQUIPPED)

With cruise control/speed control set, you can maintain a speed of 30 mph (48 km/h) or more without keeping your foot on the accelerator pedal. Cruise control/Speed control does not work at speeds below 30 mph (48 km/h).

**WARNING: Using cruise control in the following conditions could cause you to lose control of the vehicle:**

- Heavy or unsteady traffic
  - Slippery or winding roads
  - Similar restrictions that require inconsistent speed
- Don't use cruise control in these situations.

### Setting cruise control/speed control

The controls for using your cruise control/speed control are located on the steering wheel for your convenience.

1. Press the ON control and release it.
2. Accelerate to the desired speed.
3. Press the SET ACC control and release it.
4. Take your foot off the accelerator pedal.

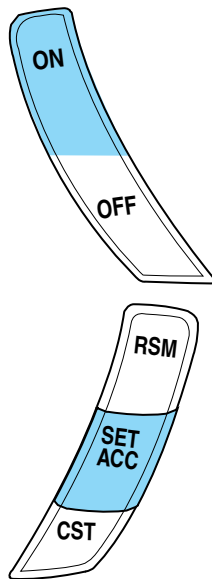

## Driver Controls

### Note:

- Vehicle speed may vary momentarily when driving up and down a steep hill.
- If the vehicle speed increases above the set speed on a downhill, you may want to apply the brakes to reduce the speed.
- If the vehicle speed decreases more than 10 mph (16 km/h) below your set speed on an uphill, your cruise control/speed control will disengage.

### Resuming a set speed

Press the RSM (resume) control and release it. This will automatically return the vehicle to the previously set speed. The RSM control will not work if the vehicle speed is not faster than 30 mph (48 km/h).

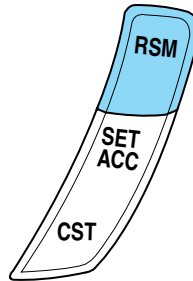

### Increasing speed while using cruise control/speed control

There are two ways to set a higher speed:

- Press and hold the SET ACC control until you get to the desired speed, then release the control. You can also use the SET ACCEL control to operate the Tap-Up function. Press and release this control to increase the vehicle set speed in small amounts by 1 mph (1.6 km/h).
- Use the accelerator pedal to get to the desired speed. When the vehicle reaches that speed press and release the SET ACC control.

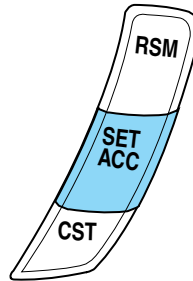

## Driver Controls

### **Reducing speed while using cruise control/speed control**

There are two ways to reduce a set speed:

- Press and hold the CST control until you get to the desired speed, then release the control. You can also use the CST control to operate the Tap-Down function. Press and release this control to decrease the vehicle set speed in small amounts by 1 mph (1.6 km/h).
- Depress the brake pedal until the desired vehicle speed is reached, press the SET ACC control.

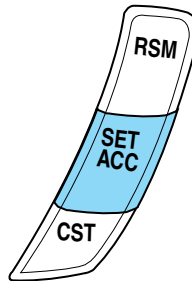
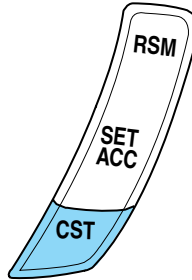

### **Turning off cruise control/speed control**

There are two ways to turn off the cruise control/speed control:

- Depress the brake pedal or the clutch pedal (if equipped). This will not erase your vehicle's previously set speed.
- Press the cruise control/speed control OFF control.

**Note:** When you turn off the cruise control/speed control or the ignition, your cruise control/speed control set speed memory is erased.

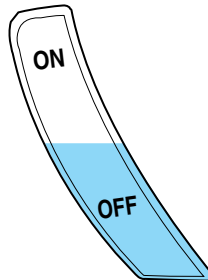

## Driver Controls

### MOON ROOF (IF EQUIPPED)

To operate the moon roof:

- The moon roof is equipped with an automatic, one-touch, express opening feature. Press and release the rear portion of the control. To stop motion at any time during the one-touch opening, press the control a second time.

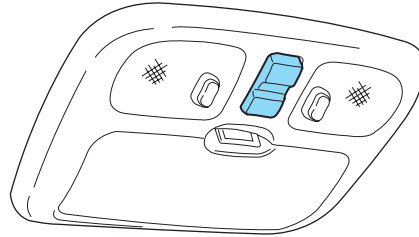

- To close, press and hold the front portion of the control.

To operate the moon roof vent position:

- To open, press and hold the front portion of the control. This will open the vent.
- To close, press and hold the rear portion of the control.

**NOTE:** If the battery is disconnected, discharged, or a new battery is installed, the moon roof needs to be opened to the vent position to reset the moon roof positions.

**NOTE:** If you open and close the moon roof repeatedly, the moon roof motor may overheat and shut down for 45 seconds while the motor cools.

**WARNING: Do not let children play with the moon roof or leave children unattended in the vehicle. They may seriously hurt themselves.**

**WARNING: When closing the moon roof, you should verify that it is free of obstructions and ensure that children and/or pets are not in the proximity of the moon roof opening.**

## Driver Controls

### LIFTGATE

To open the rear window, pull the right side of the liftgate handle.

To open the liftgate, pull the left side of the liftgate handle.

- Do not open the liftgate or liftgate glass in a garage or other enclosed area with a low ceiling. If the liftgate glass is raised and the liftgate is also opened, both liftgate and glass could be damaged against a low ceiling.
- Do not leave the liftgate or liftgate glass open while driving. Doing so could cause serious damage to the liftgate and its components as well as allowing carbon monoxide to enter the vehicle.

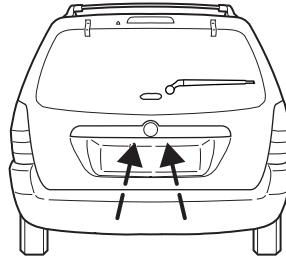

**WARNING: Make sure that the liftgate door and/or window are closed to prevent exhaust fumes from being drawn into the vehicle. Exhaust fumes contain carbon monoxide which can injure your lungs and cause drowsiness and even death. This will also prevent passengers and cargo from falling out. If you must drive with the liftgate door or window open, keep the vents open so outside air comes into the vehicle.**

### CARGO SHADE (IF EQUIPPED)

If your vehicle has a cargo shade, you can use it to cover items in the cargo area of your vehicle.

To install the shade:

- Insert the ends of the cargo shade into the mounting features located behind the rear seat on the rear trim panels.

To operate the shade:

1. Grasp the handle at the rear edge of the shade and pull rearward.
2. Secure both ends of the support rod into the retention slots located on the rear quarter trim panels.

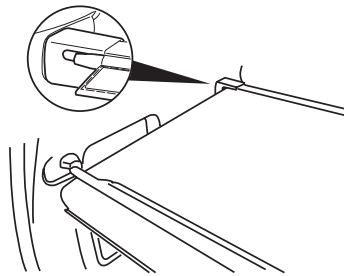

## Driver Controls

**WARNING:** Ensure that the posts are properly latched in mounting features. The cover may cause injury in a sudden stop or accident if it is not securely installed.

**WARNING:** Do not place any objects on the cargo area shade. They may obstruct your vision or strike occupants of vehicle in the case of a sudden stop or collision.

**WARNING:** Not securing luggage or cargo while driving is dangerous as it could move or be crushed during sudden braking or a collision and cause injury. Make sure luggage and cargo is secured before driving.

### LUGGAGE RACK

The maximum load for the roof rack is 100 lbs (45 kg), evenly distributed on the cross-bars. If it is not possible to evenly distribute the load, position it in the center or as far forward on the cross-bars (if equipped) as possible. Always use the adjustable tie down loops to secure the load.

#### **To adjust the cross-bar (if equipped) position:**

1. Loosen the thumbwheel at both ends of the cross-bar (both cross-bars are adjustable).
2. Slide the cross-bar to the desired location.
3. Tighten the thumbwheel at both ends of the cross-bar.

## Driver Controls

### **To remove the cross-bar assembly (if equipped) from the roof rack side rails:**

1. Loosen the thumbwheel at both ends of the cross-bar (both cross-bars are adjustable).
2. Slide the cross-bar to the end of the rail.
3. Use a long, flat object to depress the tongue in the endcaps on both sides of the cross-bar.
4. Slide the cross-bar assembly off the end of the rail.

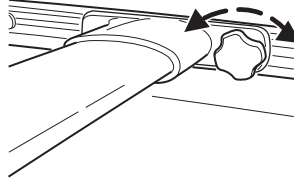

### **To reinstall the cross-bar assembly (if equipped) to the roof rack side rails:**

1. Slide the cross-bar assemblies over the end cap tongue and into the side rails.
2. Tighten thumbwheel at both ends of the cross-bar.



## Locks and Security



### KEYS

One key operates all the locks and starts the vehicle. Always carry a spare key with you in case of an emergency.

Your keys are programmed to your vehicle; using a non-programmed key will not permit your vehicle to start. If you lose your dealer supplied keys, replacement keys are available through your authorized dealer. Refer to the *SecuriLock<sup>™</sup> passive anti-theft system* section later in this chapter for more information.

### POWER DOOR LOCKS

The power door lock control is located on the driver door panel.

Pressing the  will unlock all the doors. Pressing the  will lock all the doors.

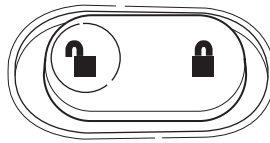

### Power door lock/unlock inhibit feature

As a theft deterrent, the power door lock controls can be disabled 20 seconds after the ignition has been turned to the 1 (LOCK) position and the vehicle is locked using the remote entry transmitter or the key in the door lock cylinder. The door lock controls are reenabled when the vehicle is unlocked using the key in the door lock cylinder or by pressing  on the remote entry transmitter. This feature can be turned on or off using the following procedure:

Before starting, ensure the ignition is in the 1 (LOCK) position and all vehicle doors are closed. You must complete Steps 1–5 within 30 seconds or the procedure will have to be repeated.

1. Place the key in the ignition and turn the ignition to the 3 (ON) position.
2. Press the power door unlock control on the door panel three times.
3. Turn the ignition from the 3 (ON) position to the 1 (LOCK) position.
4. Press the power door unlock control on the door panel three times.
5. Turn the ignition back to the 3 (ON) position. The horn will chirp one time to confirm programming mode has been entered and is active.
6. Press the power door lock control on the door panel two times within five seconds. The horn will chirp two times to confirm the feature is off; the horn will chirp two times and honk one time to confirm the feature is on.

## Locks and Security

7. Turn the ignition from the 3 (ON) position to the 1 (LOCK) position. The horn will chirp one time to confirm the programming mode has been exited.

Repeat the procedure to turn the feature on or off.

### Door key unlocking/locking

#### *Two step door unlocking*

1. Turn the key in the door cylinder to unlock the driver's door. **Note:** The interior lamps will illuminate if the control on the overhead lamp is in the DOOR position and the perimeter alarm system (if equipped) will deactivate. For more information, refer to *Illuminated entry* later in this chapter.
2. Turn the key in the door cylinder again within three seconds to unlock the passenger doors, the liftgate and liftgate glass.

#### *One step door unlocking*

If the one step door unlocking feature is activated, turn the key in the door cylinder once to unlock all of the doors, the liftgate and liftgate glass. **Note:** The interior lamps will illuminate (refer to the *Illuminated entry* feature later in this section), if the control on the overhead lamp is in the DOOR position. For information on switching from two step to one step door unlocking, refer to *Switching from two step to one step door unlocking* later in this chapter.

#### *Locking the doors*

Turn the key in the door cylinder to lock all the doors. The park/turn lamps will flash once and the perimeter alarm (if equipped) will start the arming process. For more information concerning the perimeter alarm, refer to *Perimeter alarm system (if equipped)* later in this chapter.

If any of the doors, the liftgate or the hood are not properly closed the park/turn lamps will not flash.

#### **Smart unlocking feature**

The smart unlocking feature helps prevent you from locking yourself out of the vehicle. With the key in any ignition position, the driver's door will automatically unlock if it is locked using the power lock control on the driver's door panel while the driver's door is open.

## Locks and Security

### CHILDPROOF DOOR LOCKS

- When these locks are set, the rear doors cannot be opened from the inside.
- The rear doors can be opened from the outside when the doors are unlocked.

The childproof locks are located on rear edge of each rear door and must be set **separately** for each door. Setting the lock for one door will **not** automatically set the lock for both doors.

- Rotate lock control in the direction of arrow to engage the lock.
- Rotate control in the opposite direction to disengage childproof locks.

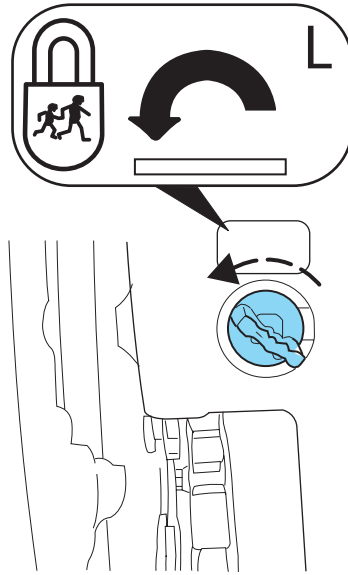

### REMOTE ENTRY SYSTEM (IF EQUIPPED)

This device complies with part 15 of the FCC rules and with RS-210 of Industry Canada. Operation is subject to the following two conditions: (1) This device may not cause harmful interference, and (2) This device must accept any interference received, including interference that may cause undesired operation.

**Changes or modifications not expressly approved by the party responsible for compliance could void the user's authority to operate the equipment.**

The typical operating range for your remote entry transmitter is approximately 33 feet (10 meters). A decrease in operating range could be caused by:

- weather conditions,
- nearby radio towers,
- structures around the vehicle,
- other vehicles parked next to your vehicle, or

## Locks and Security

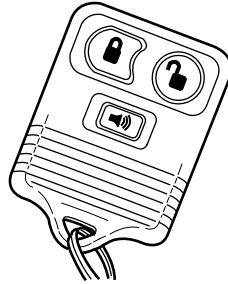

- weak or dead transmitter battery.

The remote entry system allows you to lock or unlock all vehicle doors without a key. The remote locking and unlocking features will operate independent of the ignition position; however, the panic feature will only operate when the ignition is in the 1 (LOCK) or 2 (ACCESSORY) position.



If there are problems with the remote entry system, make sure to take **ALL remote entry transmitters** with you to the dealership in order to aid in troubleshooting the problem.



### Two step door unlocking

1. Press  and release to unlock the driver's door. **Note:** The interior lamps will illuminate if the control on the overhead lamp is in the DOOR position and the perimeter alarm system (if equipped) will deactivate.
2. Press  and release again within three seconds to unlock the passenger doors, the liftgate and liftgate glass.

### One step door unlocking



If the one step door unlocking feature is activated, press  and release once to unlock all of the doors, the liftgate and liftgate glass. **Note:** The interior lamps will illuminate (refer to the *Illuminated entry* feature later in this section), if the control on the overhead lamp is in the DOOR position and the perimeter alarm system (if equipped) will deactivate.

### Switching from two step to one step door unlocking

Unlocking can be switched between two step and one step door unlocking by pressing and holding both  and  buttons simultaneously on the remote entry transmitter for approximately 4 seconds. The parklamps will flash twice to indicate that the vehicle has switched to one step unlocking. Repeat the procedure to switch back to two step unlocking.

## Locks and Security

### Locking the doors

1. Press  and release to lock all the doors. Assuming all vehicle doors and the liftgate are properly closed, the park/turn lamps will flash once and the perimeter alarm (if equipped) will start the arming process. For more information concerning the perimeter alarm, refer to *Perimeter alarm system (if equipped)* later in this chapter.
2. Press  and release again within three seconds to confirm that all the doors and liftgate are closed and locked. **Note:** The doors will lock again and the horn will chirp once.

If any of the doors or the hood are not properly closed, the horn will chirp twice and park/turn lamps will not flash when the  control is pressed.

### Sounding a panic alarm

Press  to activate the alarm. To deactivate the feature, press the control again, turn the ignition to the 3 (ON) or 4 (START) position, or wait for the alarm to time out in approximately 3 minutes.

**Note:** The panic alarm will only operate when the ignition is in the 1 (LOCK) or 2 (ACCESSORY) position.

### Replacing the battery

The remote entry transmitter uses one coin type three-volt lithium battery CR2032 or equivalent.

To replace the battery:

1. Twist a thin coin between the two halves of the remote entry transmitter near the key ring. **DO NOT TAKE THE RUBBER COVER AND CIRCUIT BOARD OFF THE FRONT HOUSING OF THE REMOTE ENTRY TRANSMITTER.**

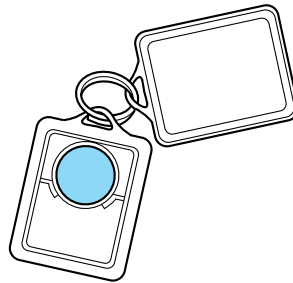

## Locks and Security

2. Do not wipe off any grease on the battery terminals on the back surface of the circuit board.

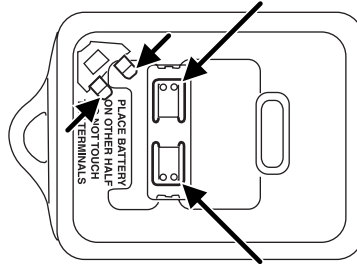

3. Remove the old battery. **Note:** Please refer to local regulations when disposing of transmitter batteries.
4. Insert the new battery. Refer to the diagram inside the remote entry transmitter for the correct orientation of the battery. Press the battery down to ensure that the battery is fully seated in the battery housing cavity.
5. Snap the two halves back together.

**Note:** Replacement of the battery will **not** cause the remote transmitter to become deprogrammed from your vehicle. The remote transmitter should operate normally after battery replacement.

### Replacing lost remote entry transmitters

If you would like to have your remote entry transmitter reprogrammed because you lost one, or would like to buy additional remote entry transmitters, you can either reprogram them yourself, or take **all remote entry transmitters** to your authorized Mazda dealer for reprogramming.

### *How to reprogram your remote entry transmitters*

You must have **all remote entry transmitters** (maximum of four) available before beginning this procedure. **Note:** If all remote entry transmitters are not present during the programming procedure, the missing transmitters will not work with the vehicle following programming.

## Locks and Security

To reprogram the remote entry transmitters:

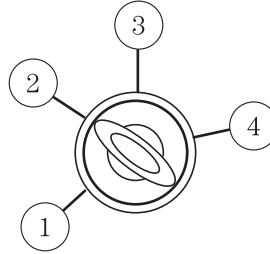

1. Ensure the vehicle is electronically unlocked.
2. Put the key in the ignition.
3. Turn the key from the 1 (LOCK) position to 3 (ON).
4. Cycle eight times rapidly (within 10 seconds) between the 1 (LOCK) position and 3 (RUN). **Note:** The eighth turn must end in the 3 (ON) position.
5. The doors will lock, then unlock, to confirm that the programming mode has been activated.
6. Within 20 seconds press any button on the remote entry transmitter. **Note:** If more than 20 seconds have passed you will need to start the procedure over again.
7. The doors will lock, then unlock, to confirm that this remote entry transmitter has been programmed.
8. Repeat Step 6 to program each additional remote entry transmitter.
9. Turn the ignition to the 1 (LOCK) position after you have finished programming all of the remote entry transmitters.
10. The doors will lock, then unlock, to confirm that the programming mode has been exited.

### Illuminated entry

The interior lamps illuminate when the remote entry system is used to unlock the door(s).

The illuminated entry system will turn off the interior lights if:

- the ignition switch is turned to the 2 (ACCESSORY) position, or
- the remote transmitter lock control is pressed, or
- the doors are locked by key in the door cylinder, or
- after 25 seconds of illumination.

## Locks and Security

### Illuminated exit

- The interior lights will illuminate when the key is removed from the ignition.

The lamps automatically turn off after 25 seconds. The dome and cargo lamp controls must **not** be set to the OFF position for the illuminated exit system to operate.

### SECURILOCK™ PASSIVE ANTI-THEFT SYSTEM

SecuriLock™ passive anti-theft system is an engine immobilization system. This system is designed to help prevent the engine from being started unless a **coded key programmed to your vehicle** is used.

The SecuriLock™ passive anti-theft system is not compatible with non-Mazda aftermarket remote start systems. Use of these systems may result in vehicle starting problems and a loss of security protection.

Your vehicle comes with two coded keys; additional coded keys may be purchased from your dealer. The dealer can program your spare keys to your vehicle or you can program the keys yourself. Refer to *Programming spare keys* for instructions on how to program the coded key.

**Note:** A maximum of eight keys can be coded to your vehicle.

**Note:** Large metallic objects, electronic devices that are used to purchase gasoline or similar items, or a second coded key on the same key chain may cause vehicle starting issues. You need to prevent these objects from touching the coded key while starting the engine. These objects will not cause damage to the coded key, but may cause a momentary issue if they are too close to the key when starting the engine. If a problem occurs, turn the ignition off, remove all objects on the key chain away from the coded key and restart the engine.

### Theft indicator

The theft indicator is located in the instrument cluster.



- When the ignition is in the 1 (LOCK) position, the **THEFT** indicator will flash once every 2 seconds to indicate the SecuriLock™ system is functioning as a theft deterrent.
- When the ignition is in the 3 (ON) position, the **THEFT** indicator will glow for 3 seconds, then turn off to indicate normal system functionality.



## Locks and Security

If a problem occurs with the SecuriLock<sup>™</sup> system, the indicator will flash rapidly or glow steadily when the ignition is in the 3 (ON) position. If this occurs, the vehicle should be taken to an authorized Mazda dealer for service.

### Replacement keys

If your keys are lost or stolen and you don't have an extra coded key, you will need to have your vehicle towed to a dealership. The key codes need to be erased from your vehicle and new coded keys and key codes will need to be programmed.

Replacing coded keys can be very costly. Store an extra programmed key away from the vehicle in a safe place to help prevent any inconveniences. Please visit an authorized Mazda dealer to purchase additional spare or replacement keys.

**WARNING: If an unprogrammed key is used in the ignition it will cause a “no start” condition.**

### Programming spare keys

You can program your own coded keys to your vehicle.

#### Tips:

- A maximum of eight keys can be coded to your vehicle.
- Only use SecuriLock<sup>™</sup> keys.
- You must have two previously programmed coded keys (keys that already operate your vehicle's engine) and the new unprogrammed key(s) readily accessible.
- If two previously programmed coded keys are not available, you must take your vehicle to your Mazda dealer to have the spare key(s) programmed.

## Locks and Security

Please read and understand the entire procedure before you begin.

1. Insert the first previously programmed **coded key** into the ignition.

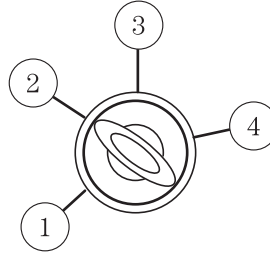

2. Turn the ignition from the 1 (LOCK) position to the 3 (ON) position. Keep the ignition in the 3 (ON) position for at least three seconds, but no more than 10 seconds.
3. Turn the ignition to the 1 (LOCK) position and remove the first **coded key** from the ignition.
4. Within ten seconds of turning the ignition to the 1 (LOCK) position, insert the second previously **coded key** into the ignition.
5. Turn the ignition from the 1 (LOCK) position to the 3 (ON) position. Keep the ignition in the 3 (ON) position for at least three seconds, but no more than 10 seconds.
6. Turn the ignition to the 1 (LOCK) position and remove the second previously programmed **coded key** from the ignition.
7. Within twenty seconds of turning the ignition to the 1 (LOCK) position and removing the previously programmed **coded key**, insert the new unprogrammed key (new key/valet key) into the ignition.
8. Turn the ignition from the 1 (LOCK) position to the 3 (ON) position. Keep the ignition in the 3 (ON) position for at least three seconds but not more than 10 seconds.
9. Remove the newly programmed **coded key** from the ignition.

If the key has been successfully programmed it will start the vehicle's engine and the theft indicator light will illuminate for three seconds and then go out.

If the key was not successfully programmed, it will not start your vehicle's engine and the theft indicator light will flash on and off; you may need to repeat Steps 1 through 5. If failure repeats, take your vehicle to your authorized Mazda dealer to have the new key(s) programmed.

To program additional new unprogrammed key(s), wait twenty seconds and then repeat this procedure from Step 1.

## Locks and Security

### PERIMETER ALARM SYSTEM (IF EQUIPPED)

The perimeter anti-theft system will warn you in the event of an unauthorized entry to your vehicle.

If there is any potential perimeter anti-theft problem with your vehicle, ensure **ALL remote entry transmitters** are taken to the dealership to aid in troubleshooting.

#### Arming the system

When armed, this system will respond if unauthorized entry is attempted. When unauthorized entry occurs, the system will flash the park/turn lamps and will sound the horn.

The system is ready to arm whenever the key is removed from the ignition. Any of the following actions will prearm the alarm system:

- Press the  control on the remote entry transmitter.
- Lock the doors with the key in the key cylinder.
- Open the driver's door and press the power door lock control to lock all the doors, and then close the door.

**Note:** The doors, liftgate and hood will arm individually, and if any of them are open, they must be closed in order to be armed.

When you lock the vehicle using any of the methods above:

- the park/turn lamps will flash once to indicate the hood, each door and the liftgate are closed.
- the park/turn lamps will **not** flash if the hood, any door or the liftgate are open. Once all doors, hood and liftgate are closed, the park/turn lamps will flash to confirm the alarm will be set.

When the vehicle is locked, the alarm is set after a 20-second arming period.

When you press the  control on the remote entry transmitter twice within three seconds, the horn will chirp once to confirm the doors, liftgate and hood are closed and locked, and the alarm is set.

## Locks and Security

### Disarming the system



You can disarm the system by any of the following actions:

- Unlock the doors by pressing the  control on your remote entry transmitter.
- Unlock the doors with a key. Turn the key full travel (toward the front of the vehicle) to ensure the alarm disarms.
- Turning the key in the ignition to the 3 (ON) or 4 (START) position.

### Triggering the anti-theft system

The armed system will be triggered if any door, liftgate or the hood is opened without using the key or the remote entry transmitter.

To deactivate the triggered alarm state:

- Unlock the doors by pressing the  control on your remote entry transmitter.
- Unlock the doors with a key. Turn the key full travel (toward the front of the vehicle) to ensure the alarm disarms.
- Press  on the remote entry transmitter to disable the alarm; the alarm will be disabled, but the vehicle will remain in an armed state.
- Turning the key in the ignition to the 3 (ON) or 4 (START) position.  
**Note:** The key must be a valid, programmed, coded key.

## Seating and Safety Restraints

### SEATING

#### Adjustable head restraints

The purpose of these head restraints is to help limit head motion in the event of a rear collision. To properly adjust your head restraints, lift the head restraint so that it is located directly behind your head or as close to that position as possible.

The head restraints can be moved up and down.

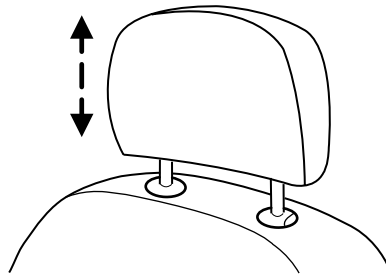

Push side control and push down on head restraint to lower it.

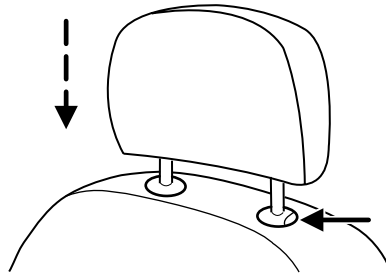

#### Adjusting the front manual seat

**WARNING: Never adjust the driver's seat or seatback when the vehicle is moving. Sudden braking or a collision could cause serious injury. Adjust the seat only when the vehicle is stopped.**

**WARNING: Do not pile cargo higher than the seatbacks to reduce the risk of injuring people in a collision or sudden stop.**

## Seating and Safety Restraints

**WARNING:** Not securing luggage or cargo while driving is dangerous as it could move or be crushed during sudden braking or a collision and cause injury. Make sure luggage and cargo are secured before driving.

**WARNING:** Always drive and ride with your seatback upright and the lap belt snug and low across the hips and the shoulder belt snug across the chest.

**WARNING:** Sitting in a reclined position while the vehicle is moving is dangerous because you don't get the full protection from safety belts. During sudden braking or a collision, you can slide under the lap belt and suffer serious internal injury, or in a rear end collision you could fly up and out of the vehicle. For maximum protection, sit well back and upright.

Lift handle to move seat forward or backward.

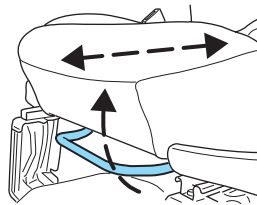

Pull lever up to adjust seatback.

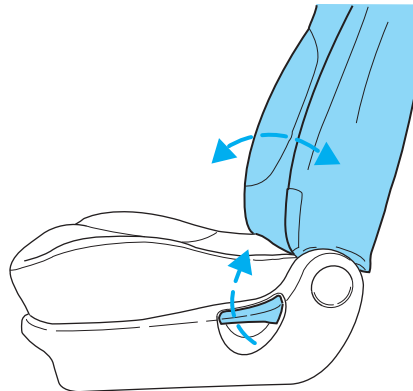

## Seating and Safety Restraints

### Using the manual lumbar support (if equipped)

The lumbar support control is located on the inboard side of the driver's seatback.

Turn the lumbar support control clockwise to increase firmness.

Turn the lumbar support control counterclockwise to increase softness.

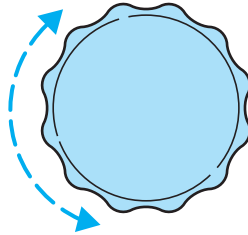

### Adjusting the front power seat (if equipped)

**WARNING:** Never adjust the driver's seat or seatback when the vehicle is moving. You could move out of position to control the vehicle. Then a serious accident could occur. Sudden braking or a collision could cause serious injury. Adjust the seat only when the vehicle is stopped.

**WARNING:** Do not pile cargo higher than the seatbacks to reduce the risk of injuring people in a collision or sudden stop.

**WARNING:** Always drive and ride with your seatback upright and the lap belt snug and low across the hips and the shoulder belt snug across the chest.

**WARNING:** Sitting in a reclined position while the vehicle is moving is dangerous because you don't get the full protection from safety belts. During sudden braking or a collision, you can slide under the lap belt and suffer serious internal injury, or in a rear end collision you could fly up and out of the vehicle. For maximum protection, sit well back and upright.

The control is located on the outboard side of the seat cushion.

## Seating and Safety Restraints

Move the front of the control up or down to raise or lower the front portion of the seat cushion.

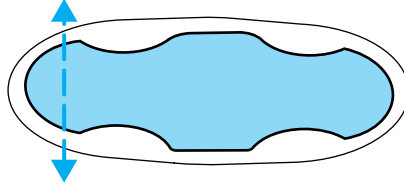

Move the rear of the control up or down to raise or lower the rear portion of the seat cushion.

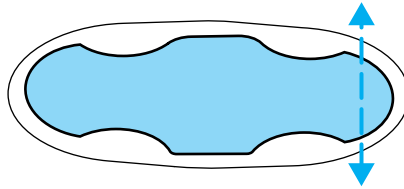

Move the control in the directions shown to move the seat forward, backward, up or down.

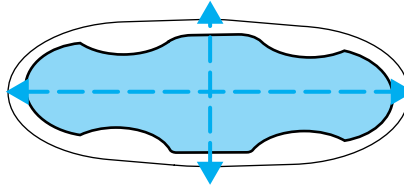

### Heated seats (if equipped)

To operate the heated seats:

- Push the control located on the seat to activate.
- Push again to deactivate.

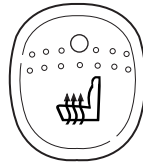

The heated seats will activate when the ignition is in the RUN position.

### REAR SEATS

#### Head restraints (if equipped)

The purpose of these head restraints is to help limit head motion in the event of a rear collision. To properly adjust your head restraints, lift the head restraint so that it is located directly behind your head or as close to that position as possible.



## Seating and Safety Restraints

The head restraints can be moved up and down.

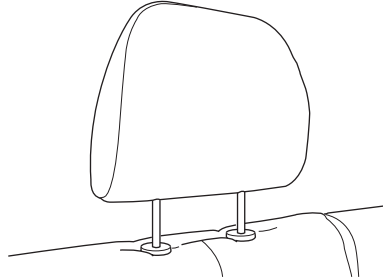

Push control to lower head restraint.

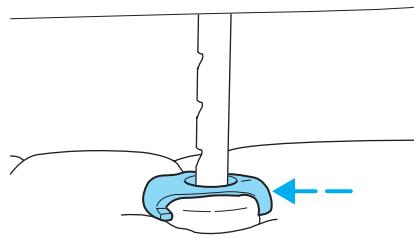

### Folding down rear seats (60/40 split bench)

1. Raise the rear seat head restraint and remove.

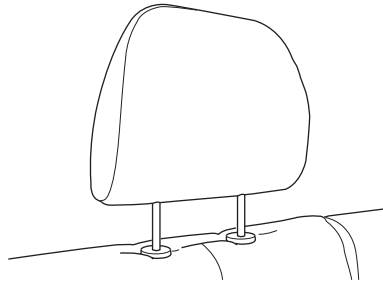

2. Place the head restraint under the front seat for storage.

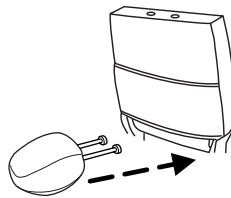

## Seating and Safety Restraints

3. Pull the seat release control.

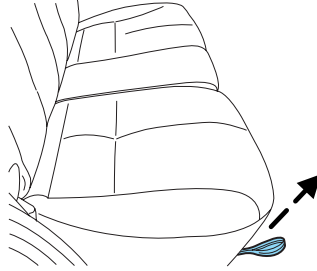

**NOTE:** Make sure the floor is clear of all objects before folding the seat.

4. Flip seat forward.

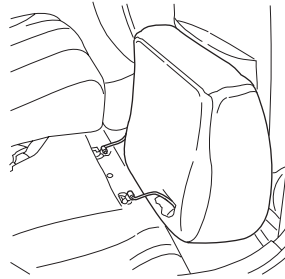

Attach the safety belt web snap button to the quarter trim panel snap button. This will assure that seatbelt does not get caught by staying out of the seat back folding path.

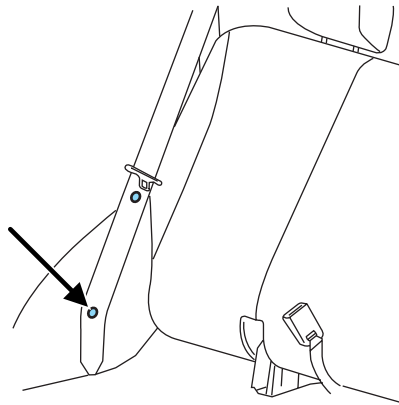

## Seating and Safety Restraints

5. To release seatback, pull the seatback release lever (on top of seat) toward the front seat. This is common for both 60% and 40% seatbacks.

**NOTE:** When the seatback release lever is pulled, slowly lower seatback to the flat position.

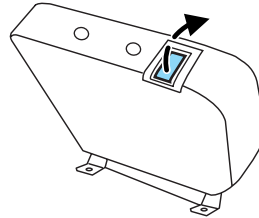

6. Rotate seatback down into load floor position.

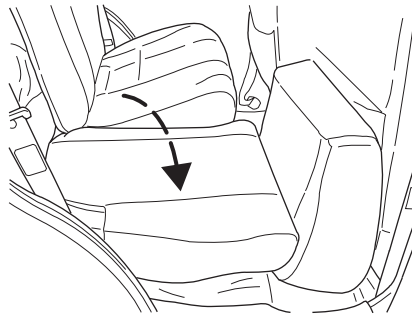

### **Returning the rear seats to upright position**

1. Pull seatback up and into upright position making sure seatback locks into place.

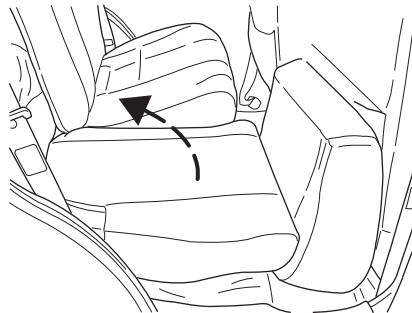

## Seating and Safety Restraints

2. Rotate seat cushion down into the seating position making sure that the seat cushion is locked into place and the RED seat unlatched indicator on release paddle is not visible.

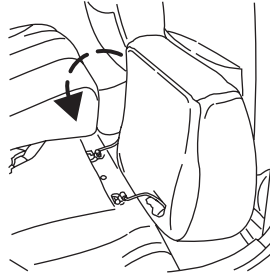

**WARNING: Make sure safety belt buckle heads are through elastic holders on seat backs. Safety belt buckle heads may break if they are trapped underneath the seatback as the seatback is rotated down.**

**WARNING: Before returning the seatback to its original position, make sure that cargo or any objects are not trapped underneath the seatback. After returning the seatback to its original position, pull on the seatback to ensure that it has fully latched. An unlatched seat may become dangerous in the event of a sudden stop or collision.**

3. Remove the head restraints stored under the front passenger seat and return them to the original position on the seat backs.

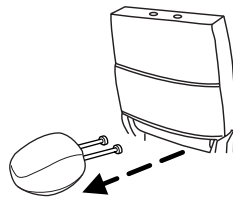

## Seating and Safety Restraints

### To remove the rear cushion

1. Lift the yellow tab to release the hinges.
2. Pull the cushion to the outboard side of the vehicle.

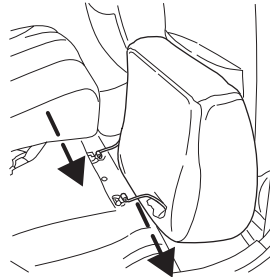

### To install the rear cushion

1. Push the cushion to the inboard side of the vehicle.
2. Make sure that the hinges are locked into place.

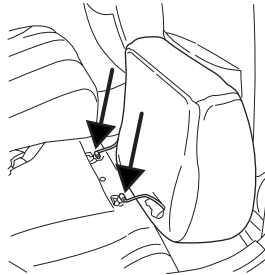

## SAFETY RESTRAINTS

### Personal Safety System™

The Personal Safety System™ provides an improved overall level of frontal crash protection to front seat occupants and is designed to help further reduce the risk of airbag-related injuries. The system is able to analyze different occupant conditions and crash severity before activating the appropriate safety devices to help better protect a range of occupants in a variety of frontal crash situations.

Your vehicle's Personal Safety System™ consists of:

- Driver and passenger dual-stage airbag supplemental restraints.
- Front safety belts with pretensioners, load limiter (first row only), and safety belt usage sensors.
- Passenger occupant classification sensor (OCS)
- Front crash severity sensor.

## Seating and Safety Restraints

- Restraints Control Module (RCM) with impact and safing sensors.
- Restraint system warning light and back-up tone.
- The electrical wiring for the airbags, crash sensor(s), safety belt pretensioners, front safety belt usage sensors, driver seat position sensor, passenger occupant classification sensor, and indicator lights.

### **How does the Personal Safety System™ work?**

The Personal Safety System™ can adapt the deployment strategy of your vehicle's safety devices according to crash severity and occupant conditions. A collection of crash and occupant sensors provides information to the Restraints control module (RCM). During a crash, the RCM activates the safety belt pretensioners and/or either one or both stages of the dual-stage airbag supplemental restraints based on crash severity and occupant conditions.

The fact that the pretensioners or airbags did not activate for both front seat occupants in a collision does not mean that something is wrong with the system. Rather, it means the Personal Safety System™ determined the accident conditions (crash severity, belt usage, etc.) were not appropriate to activate these safety devices. Front airbags and pretensioners are designed to activate only in frontal and near-frontal collisions, not rollovers, side-impacts, or rear-impacts unless the collision causes sufficient longitudinal deceleration.

### **Driver and passenger dual-stage airbag supplemental restraints**

The dual-stage airbags offer the capability to tailor the level of airbag inflation energy. A lower, less forceful energy level is provided for more common, moderate-severity impacts. A higher energy level is used for the most severe impacts. Refer to *Airbag supplemental restraints* section in this chapter.

### **Front crash severity sensor**

The front crash severity sensor enhances the ability to detect the severity of an impact. Positioned up front, it provides valuable information early in the crash event on the severity of the impact. This allows your Personal Safety System™ to distinguish between different levels of crash severity and modify the deployment strategy of the dual-stage airbags and safety belt pretensioners.

### **Driver's seat position sensor**

The driver's seat position sensor allows your Personal Safety System™ to tailor the deployment level of the driver dual-stage airbag based on seat position. The system is designed to help protect smaller drivers sitting close to the driver airbag by providing a lower airbag output level.

## Seating and Safety Restraints

### **Occupant Classification Sensor (OCS)**

For airbags to do their job they must inflate with great force, and this force can pose a potentially deadly risk to occupants that are very close to the airbag when it begins to inflate. For some occupants, like infants in rear-facing child seats, this occurs because they are initially sitting very close to the airbag. For other occupants, this occurs when the occupant is not properly restrained by safety belts or child safety seats and they move forward during pre-crash braking. The most effective way to reduce the risk of unnecessary injuries is to make sure all occupants are properly restrained. Accident statistics suggest that children are much safer when properly restrained in the rear seating positions than in the front.

**WARNING: Air bags can kill or injure a child in a child seat. NEVER place a rear-facing child seat in front of an active air bag. If you must use a forward-facing child seat in the front seat, move the seat all the way back.**

**WARNING: Always transport children 12 years old and under in the back seat and always properly use appropriate child restraints.**

The front passenger sensing system can automatically turn off the passenger front airbag. The system is designed to help protect small (child size) occupants from airbag deployments when they are improperly seated or restrained in the front passenger seat contrary to proper child-seating or restraint usage recommendations. Even with this technology, parents are **STRONGLY** encouraged to always properly restrain children in the rear seat. The sensor also turns off the passenger front airbag and seat-mounted side airbag (if equipped) when the passenger seat is empty to prevent unnecessary replacement of airbag(s) after a collision.

When the front passenger seat is occupied and the sensing system has turned off the passenger's frontal airbag, the "pass airbag off" indicator will light and stay lit to remind you that the front passenger frontal airbag is off. See *Front passenger sensing system* in the airbags section of this chapter.

### **Front safety belt usage sensors**

The front safety belt usage sensors detect whether or not the driver and front outboard passenger safety belts are fastened. This information

## Seating and Safety Restraints

allows your Personal Safety System<sup>™</sup> to tailor the airbag deployment and safety belt pretensioner activation depending upon safety belt usage. Refer to *Safety restraints* section in this chapter.

### **Front safety belt pretensioners**

The safety belt pretensioners at the front outboard seating positions are designed to tighten the safety belts firmly against the occupant's body during a frontal or near-frontal collision. This maximizes the effectiveness of the safety belts and helps properly position the occupant relative to the airbag to improve protection. The safety belt pretensioners can be either activated alone or, if the collision is of sufficient severity, together with the airbags.

### **Front safety belt load limiter**

The front outboard safety belt load limiter allows webbing to be pulled out of the retractor in a gradual and controlled manner in response to the occupant's forward momentum. This helps reduce the risk of force-related injuries to the occupant's chest by limiting the load on the occupant. Refer to *Load limiter feature* section in this chapter.

### **Determining if the Personal Safety System<sup>™</sup> is operational**

The Personal Safety System<sup>™</sup> uses a warning light in the instrument cluster or a back-up tone to indicate the condition of the system. Refer to the *Warning light* section in the *Instrument cluster* chapter. Routine maintenance of the Personal Safety System<sup>™</sup> is not required.

The Restraints control module (RCM) monitors its own internal circuits and the circuits for the airbag supplemental restraints, crash sensor(s), safety belt pretensioners, front safety belt buckle sensors, driver seat position sensor, and passenger occupant classification sensor. In addition, the RCM also monitors the restraints warning light in the instrument cluster. A malfunction with the system is indicated by one or more of the following.

- The warning light will either flash or stay lit.
- The warning light will not illuminate immediately after ignition is turned on.
- A series of five beeps will be heard. The tone pattern will repeat periodically until the problem and warning light are repaired.

If any of these things happen, even intermittently, have the Personal Safety System<sup>™</sup> serviced by your authorized Mazda dealership immediately. Unless serviced, the system may not function properly in the event of a collision.



## Seating and Safety Restraints

### Safety restraints precautions

**WARNING:** Always drive and ride with your seatback upright and the lap belt snug and low across the hips and the shoulder belt snug across the chest.

**WARNING:** To reduce the risk of injury, make sure children sit where they can be properly restrained.

**WARNING:** Never let a passenger hold a child on his or her lap while the vehicle is moving. The passenger cannot protect the child from injury in a collision.

**WARNING:** All occupants of the vehicle, including the driver, should always properly wear their safety belts, even when an air bag supplemental restraint system (SRS) is provided.

**WARNING:** It is extremely dangerous to ride in a cargo area, inside or outside of a vehicle. In a collision, people riding in these areas are more likely to be seriously injured or killed. Do not allow people to ride in any area of your vehicle that is not equipped with seats and safety belts. Be sure everyone in your vehicle is in a seat and using a safety belt properly.

**WARNING:** In a rollover crash, an unbelted person is significantly more likely to die or be seriously injured than a person wearing a safety belt.

**WARNING:** Each seating position in your vehicle has a specific safety belt assembly which is made up of one buckle and one tongue that are designed to be used as a pair. 1) Use the shoulder belt on the outside shoulder only. Never wear the shoulder belt under the arm. 2) Never swing the safety belt around your neck over the inside shoulder. 3) Never use a single belt for more than one person.

## Seating and Safety Restraints

**WARNING:** Placing a child, 12 years or younger, in the front seat is dangerous. The child could be hit by a deploying airbag and be seriously injured or even killed. A sleeping child is more likely to lean against the door and be hit by the side airbag (if equipped) in a moderate collision. Whenever possible, always secure a child, 12 years or younger, in the rear seat, with an appropriate child restraint system for the child's age and size. Never use a rear-facing child restraint system in the front seat with an airbag that could deploy.

### Combination lap and shoulder belts

1. Insert the belt tongue into the proper buckle (the buckle closest to the direction the tongue is coming from) until you hear a snap and feel it latch. Make sure the tongue is securely fastened in the buckle.

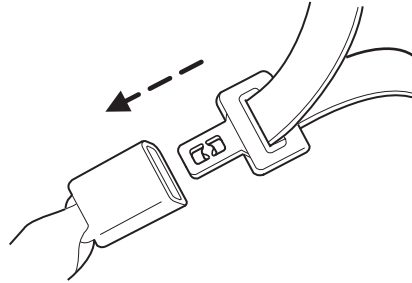

2. To unfasten, push the release button and remove the tongue from the buckle.

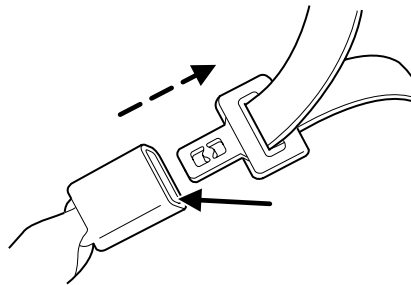

### Load Limiter Feature

- This vehicle has a safety belt system with a load limiter feature at the front seating positions to help further reduce the risk of injury in the event of a head-on collision.
- This safety belt system has a retractor assembly that is designed to pay out webbing in a controlled manner. This feature is designed to help reduce the belt force acting on the occupant's chest.

## Seating and Safety Restraints

**WARNING:** All safety belts should be checked for proper function. Additionally, if the front airbags have deployed, the front pretensioners have also deployed and both front restraints must be replaced. After any vehicle collision, the safety belt system at all outboard seating positions (except driver, which has no “automatic locking retractor” feature) must be checked by a qualified technician to verify that the “automatic locking retractor” feature for child seats is still functioning properly.

**WARNING: BELT AND RETRACTOR ASSEMBLY MUST BE REPLACED** if the safety belt assembly “automatic locking retractor” feature or any other safety belt function is not operating properly when checked according to the procedures in Workshop Manual.

**WARNING: Failure to replace the Belt and Retractor assembly could increase the risk of injury in collisions.**

All safety belts in the vehicle are combination lap and shoulder belts. The passenger safety belts have two types of locking modes described below:

### **Vehicle sensitive mode**

This is the normal retractor mode, which allows free shoulder belt length adjustment to your movements and locking in response to vehicle movement. For example, if the driver brakes suddenly or turns a corner sharply, or the vehicle receives an impact of approximately 5 mph (8 km/h) or more, the combination safety belts will lock to help reduce forward movement of the driver and passengers.

### **Automatic locking mode for use with child safety seats**

#### ***When to use the automatic locking mode***

In this mode, the shoulder belt is automatically pre-locked. The belt will still retract to remove any slack in the shoulder belt. The automatic locking mode is not available on the driver safety belt.

This mode should be used **any time** a child safety seat is installed in a passenger front or outboard rear seating position (if equipped). Children 12 years old and under should be properly restrained in the rear seat whenever possible. Refer to *Safety restraints for children* or *Safety seats for children* later in this chapter.

## Seating and Safety Restraints

### ***How to use the automatic locking mode for use with child safety seats***

- Buckle the combination lap and shoulder belt.

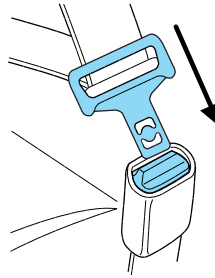

- Grasp the shoulder portion and pull downward until the entire belt is pulled out.



- Allow the belt to retract. As the belt retracts, you will hear a clicking sound. This indicates the safety belt is now in the automatic locking mode.

### ***How to disengage the automatic locking mode***

Disconnect the combination lap/shoulder belt and allow it to retract completely to disengage the automatic locking mode and activate the vehicle sensitive (emergency) locking mode.

If the safety belt is not coming out of the retractor when it looks to be fully retracted, check to see if it might still be attached to the side of the vehicle by the snaps designed to keep it out of the way when you last put the rear seat into cargo configuration. Refer to *Returning the rear seats to upright position* in this chapter.

## Seating and Safety Restraints

**WARNING:** After any vehicle collision, the safety belt systems at all seating positions (except the driver position, which doesn't have this feature) must be checked by a qualified technician to verify that the automatic locking retractor feature for child seats is still functioning properly. In addition, all safety belts should be checked for proper function.

**WARNING: BELT AND RETRACTOR ASSEMBLY MUST BE REPLACED** if the safety belt assembly “automatic locking retractor” feature or any other safety belt function is not operating properly when checked according to the procedures in Workshop Manual. Failure to replace the Belt and Retractor assembly could increase the risk of injury in collisions.

### Safety belt height adjustment

Your vehicle has safety belt height adjustments at the front outboard seating positions. Adjust the height of the shoulder belt so the belt rests across the middle of your shoulder.

To adjust the shoulder belt height, squeeze and hold the buttons on the side and slide the height adjuster up or down. Release the buttons and pull down on the height adjuster to make sure it is locked in place.

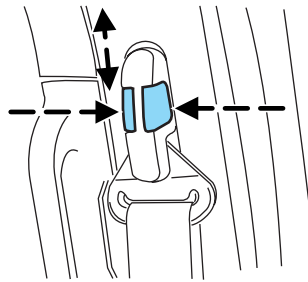

**WARNING: Position the safety belt height adjusters so that the belt rests across the middle of your shoulder. Failure to adjust the safety belt properly could reduce the effectiveness of the safety belt and increase the risk of injury in a collision.**

### Safety belt pretensioner

Your vehicle is equipped with safety belt pretensioners at the driver and right front passenger seating positions.

The safety belt pretensioner removes some slack from the safety belt system at the start of a crash. The safety belt pretensioner uses the same crash sensor system as the front airbags and side-curtain airbags (if equipped). When the safety belt pretensioner deploys, the lap and shoulder belt are tightened.

## Seating and Safety Restraints

When the side-curtain airbags (if equipped) and/or the front airbags are activated, the safety belt pretensioners for the driver and right front passenger seating positions will be activated when the respective seatbelt is properly buckled.

**WARNING: The driver and the right front passenger safety belt system (including retractors, buckles and height adjusters) must be replaced if the vehicle is involved in a collision that results in deployment of front airbags or side-curtain airbags (if equipped) and safety belt pretensioners.**

**WARNING: Failure to replace both front restraints under the above conditions could result in severe personal injuries in the event of a collision. The safety belt pretensioners will only function once. After they are deployed, they will not work again and must be replaced immediately, even if there was no front seat occupant seated at the time.**

**WARNING: Modifying the components or wiring of the pretensioner system, including the use of electronic testing devices is dangerous. You could accidentally activate it or make it inoperable which would prevent it from activating in an accident. Front occupants could be seriously injured. Never modify the components or wiring, or use electronic testing devices on the pretensioner system.**

**WARNING: Improper disposal of the pretensioner system or a vehicle with non-deactivated pretensioners is dangerous. Unless all safety procedures are followed, injury could result. Ask an authorized Mazda dealer how to safely dispose of the pretensioner system or how to scrap a front pretensioner-equipped vehicle.**

Refer to the *Safety belt maintenance* section in this chapter.

## Seating and Safety Restraints

### Safety belt extension assembly

If the safety belt assembly is too short for you, even when fully extended, 20 cm (8 inches) can be added to the safety belt assembly by adding a safety belt extension assembly. Safety belt extension assemblies can be obtained from your authorized Mazda dealership.

Use only extensions manufactured by the same supplier as the safety belt. Manufacturer identification is located at the end of the webbing on the label. Also, use the safety belt extension only if the safety belt is too short for you when fully extended.

**NOTE:** Do not use extensions to change the fit of the shoulder belt across the torso.

### Safety belt maintenance

Inspect the safety belt systems periodically to make sure they work properly and are not damaged.

**NOTE:** If unsure about the proper procedures, bring your vehicle to an authorized Mazda dealership for inspection. Inspect the safety belts to make sure there are no nicks, tears or cuts, replacing if necessary. Check all automatic locking retractors on all outboard seating positions as well as the automatic locking mode for child safety seats on the passenger front belt. All safety belt assemblies, including retractors, buckles, front safety belt buckle assemblies, buckle support assemblies (slide bar-if equipped), shoulder belt height adjusters (if equipped), shoulder belt guide on seatback (if equipped), child safety seat tether bracket assemblies (if equipped), LATCH child seat tether anchors and lower anchors (if equipped), and attaching hardware, should be inspected after a collision. Mazda recommends that all safety belt assemblies used in vehicles involved in a collision be replaced. However, if the collision was minor and an authorized Mazda technician finds that the belts do not show damage and continue to operate properly, they do not need to be replaced. Safety belt assemblies not in use during a collision should also be inspected and replaced if either damage or improper operation is noted.

The energy absorbing functions may have been activated in a collision so the restraints should be examined; if the front airbags have deployed, the pretensioners have also deployed and must be replaced — regardless of whether there was an occupant in the passenger seat or not. The optional side airbags are not connected to the pretensioners.

## Seating and Safety Restraints

**WARNING: Failure to inspect and if necessary replace the safety belt assembly under the above conditions could result in severe personal injuries in the event of a collision.**

Refer to *Interior* in the *Cleaning* chapter.

### Safety belt warning light and indicator chime

The safety belt warning light illuminates in the instrument cluster and a chime sounds to remind the occupants to fasten their safety belts.

#### Conditions of operation

If...	Then...
The driver's safety belt is not buckled before the ignition switch is turned to the ON position...	The safety belt warning light illuminates 1-2 minutes and the warning chime sounds 4-8 seconds.
The driver's safety belt is buckled while the indicator light is illuminated and the warning chime is sounding...	The safety belt warning light and warning chime turn off.
The driver's safety belt is buckled before the ignition switch is turned to the ON position...	The safety belt warning light and indicator chime remain off.

### BeltMinder™

The BeltMinder™ feature is a supplemental warning to the safety belt warning function. This feature provides additional reminders by intermittently sounding a chime and illuminating the safety belt warning lamp in the instrument cluster when the driver's and front passenger's safety belt is unbuckled.

The BeltMinder™ feature uses information from the passenger occupant classification sensor to determine if a front seat passenger is present and therefore potentially in need of a warning. To avoid activating the BeltMinder™ feature for objects placed in the front passenger seat, warnings will only be given to large front seat occupants as determined by the passenger occupant classification sensor.



## Seating and Safety Restraints

Both the driver's and passenger's safety belt usages are monitored and either may activate the BeltMinder™ feature. The warnings are the same for the driver and the front passenger. If the BeltMinder™ warnings have expired (warnings for approximately 5 minutes) for one occupant (driver or front passenger), the other occupant can still activate the BeltMinder™ feature.

If...	Then...
The driver's and front passenger's safety belts are buckled before the ignition switch is turned to the ON position or less than 1-2 minutes have elapsed since the ignition switch has been turned ON...	The BeltMinder™ feature will not activate.
The driver's or front passenger's safety belt is not buckled when the vehicle has reached at least 5 km/h (3 mph) and 1-2 minutes have elapsed since the ignition switch has been turned to ON...	The BeltMinder™ feature is activated - the safety belt warning light illuminates and the warning chime sounds for 6 seconds every 30 seconds, repeating for approximately 5 minutes or until the safety belts are buckled.
The driver's or front passenger's safety belt becomes unbuckled for approximately 1 minute while the vehicle is traveling at least 5 km/h (3 mph) and more than 1-2 minutes have elapsed since the ignition switch has been turned to ON...	The BeltMinder™ feature is activated - the safety belt warning light illuminates and the warning chime sounds for 6 seconds every 30 seconds, repeating for approximately 5 minutes or until the safety belts are buckled.

## Seating and Safety Restraints

The following are reasons most often given for not wearing safety belts  
(All statistics based on U.S. data):

Reasons given...	Consider...
"Crashes are rare events"	<b>36,700 crashes occur every day.</b> The more we drive, the more we are exposed to "rare" events, even for good drivers. <i>1 in 4 of us will be seriously injured in a crash during our lifetime.</i>
"I'm not going far"	<b>3 of 4</b> fatal crashes occur within <b>25</b> miles of home.
"Belts are uncomfortable"	Safety belts are designed to enhance comfort. If you are uncomfortable - try different positions for the safety belt upper anchorage and seatback which should be as upright as possible; this can improve comfort.
"I was in a hurry"	<b>Prime time for an accident.</b> Safety Belt Warning Chime reminds us to take a few seconds to buckle up.
"Seat belts don't work"	<b>Safety belts</b> , when used properly, <b>reduce risk of death</b> to front seat occupants by <b>45% in cars</b> , and by <b>60% in light trucks</b> .
"Traffic is light"	<b>Nearly 1 of 2 deaths occur in single-vehicle crashes</b> , many when no other vehicles are around.
"Belts wrinkle my clothes"	Possibly, but a serious crash can do much more than wrinkle your clothes, particularly if you are unbelted.
"The people I'm with don't wear belts"	Set the example, teen deaths occur 4 times more often in vehicles with TWO or MORE people. Children and younger brothers/sisters imitate behavior they see.

## Seating and Safety Restraints

Reasons given...	Consider..
"I have an airbag"	Airbags offer greater protection when used with safety belts. Frontal airbags are not designed to inflate in rear and side crashes or rollovers.
"I'd rather be thrown clear"	Not a good idea. <b>People</b> who are <b>ejected are 40 times more likely to DIE</b> . Safety belts help prevent ejection, WE CAN'T "PICK OUR CRASH".

**WARNING: Always wear the safety belt. Do not be tempted to sit on top of the belt to fool police or to defeat the warning system. The safety belt and safety belt warning system are there to protect your life.**

### ***One time disable***

If at any time the driver/front passenger quickly buckles then unbuckles the BeltMinder™ feature for that seating position, the BeltMinder™ is disabled for the current ignition cycle. The BeltMinder™ feature will re-enable during the same ignition cycle if the occupant buckles and remains buckled for approximately 30 seconds. Confirmation is not given for the one time disable.

### ***Deactivating/activating the BeltMinder™ feature***

**The driver and front passenger BeltMinder™ are deactivated/activated independently. When deactivating/activating one seating position, do not buckle the other position as this will terminate the process.**

*Read Steps 1 - 4 thoroughly before proceeding with the deactivation/activation programming procedure.*

The driver and front passenger BeltMinder™ features can be deactivated/activated by performing the following procedure:

Before following the procedure, make sure that:

- The parking brake is set
- The gearshift is in P (Park)
- The ignition switch is in the OFF position
- The driver and front passenger safety belts are unbuckled

## Seating and Safety Restraints

**WARNING: To reduce the risk of injury, do not deactivate/activate the Belt Minder feature while driving the vehicle.**

1. Turn the ignition switch to the RUN (or ON) position. (DO NOT START THE ENGINE)
  2. Wait until the safety belt warning light turns off. (Approximately 1 minute)
- Step 3 must be completed within 50 seconds after the safety belt warning light turns off.
  - 3. For the seating position being disabled, buckle then unbuckle the safety belt 9 times, ending in the unbuckled state. (Step 3 must be completed within 50 seconds after the safety belt warning light turns off.)
  - After Step 3, the restraint system warning light (airbag light) will be turned on for three seconds.
  - 4. Within 10 seconds of the light turning on, buckle then unbuckle the safety belt.
  - This will disable the BeltMinder<sup>™</sup> feature for that seating position if it is currently enabled. As confirmation, the restraint system warning light will flash 4 times per second for 3 seconds.
  - This will enable the BeltMinder<sup>™</sup> feature for that seating position if it is currently disabled. As confirmation, the restraint system warning light will flash 4 times per second for 3 seconds, followed by 3 seconds with the light off, then followed by the restraint system warning light flashing 4 times per second for 3 seconds again.
  - After receiving confirmation, the deactivation/activation procedure is complete.

## Seating and Safety Restraints

### AIRBAG SUPPLEMENTAL RESTRAINT SYSTEM (SRS)

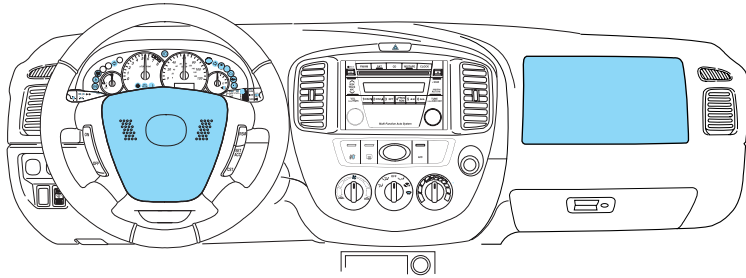

#### Important supplemental restraint system (SRS) precautions

The supplemental restraint system is designed to work with the safety belt to help protect the driver and right front passenger from certain upper body injuries.

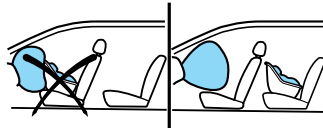

**WARNING: Airbags DO NOT inflate slowly or gently and the risk of injury from a deploying airbag is greatest close to the trim covering the airbag module.**

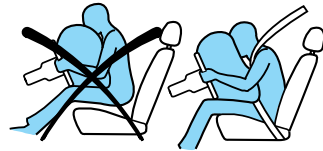

**WARNING: All occupants of the vehicle, including the driver, should always properly wear their safety belts, even when an air bag supplemental restraint system (SRS) is provided.**

**WARNING: Always transport children 12 years old and under in the back seat and always properly use appropriate child restraint systems.**

**WARNING: National Highway Traffic Safety Administration (NHTSA) recommends a minimum distance of at least 10 inches (25 cm) between an occupant's chest and the driver airbag module.**

## Seating and Safety Restraints

**WARNING:** The driver should always hold onto only the rim of the steering wheel. Never place your arm over the airbag module as a deploying airbag can result in serious arm fractures or other injuries.

Steps you can take to properly position yourself away from the airbag:

- Move your seat to the rear as far as you can while still reaching the pedals comfortably.
- Recline the seat slightly (one or two degrees) from the upright position.

**WARNING:** Do not put anything on or over the airbag module including hands or feet. Placing objects on or over the airbag inflation area may cause those objects to be propelled by the airbag into your face and torso causing serious injury.

**WARNING:** Do not attempt to service, repair, or modify the Airbag Supplemental Restraint Systems or its fuses. See your authorized Mazda dealership.

**WARNING:** Modifications to the front end of the vehicle, including frame, bumper, front end body structure, tow hooks, and snow plows may affect the performance of the airbag sensors increasing the risk of injury. Do not modify the front end of the vehicle.

**WARNING:** Additional equipment may affect the performance of the airbag sensors increasing the risk of injury. Consult your authorized Mazda dealership before installation of additional equipment.

## Seating and Safety Restraints

### Children and airbags

For additional important safety information, read all information on safety restraints in this guide.

**WARNING: Children must always be properly restrained. Accident statistics suggest that children are safer when properly restrained in the rear seating positions than in the front seating position. Failure to follow these instructions may increase the risk of injury in a collision.**

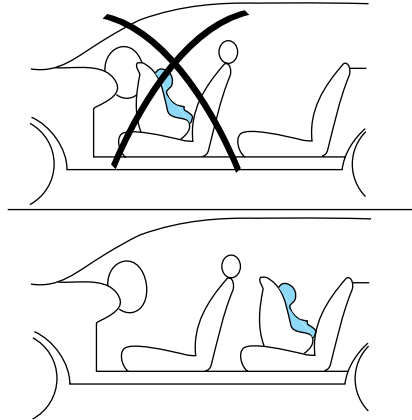

**WARNING: Airbags can kill or injure a child in a child seat. NEVER place a rear-facing child seat in front of an active airbag. If you must use a forward-facing child seat in the front seat, move the seat all the way back. Secure the seat and the child in it properly.**

### How does the airbag supplemental restraint system work?

The airbag SRS is designed to activate when the vehicle sustains longitudinal deceleration sufficient to cause the sensors to close an electrical circuit that initiates airbag inflation.

The fact that the airbags did not inflate in a collision does not mean that something is wrong with the system. Rather, it means the forces were not of the type sufficient to cause activation. Airbags are designed to inflate in frontal and near-frontal collisions, not rollover, side-impact, or rear-impacts unless the collision causes sufficient longitudinal deceleration.

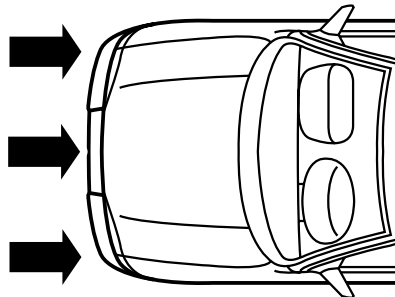

## Seating and Safety Restraints

The airbags inflate and deflate rapidly upon activation. After airbag deployment, it is normal to notice a smoke-like, powdery residue or smell the burnt propellant. This may consist of cornstarch, talcum powder (to lubricate the bag) or sodium compounds (e.g., baking soda) that result from the combustion process that inflates the airbag. Small amounts of sodium hydroxide may be present which may irritate the skin and eyes, but none of the residue is toxic.



While the system is designed to help reduce serious injuries, contact with a deploying airbag may also cause abrasions, swelling or temporary hearing loss. Because airbags must inflate rapidly and with considerable force, there is the risk of death or serious injuries such as fractures, facial and eye injuries or internal injuries, particularly to occupants who are not properly restrained or are otherwise out of position at the time of airbag deployment. Thus, it is extremely important that occupants be properly restrained as far away from the airbag module as possible while maintaining vehicle control.

**WARNING: Several airbag system components get hot after inflation. Do not touch them after inflation or you may be burned.**

**WARNING: If the airbag and safety belt pretensioners have deployed, the airbag and safety belt pretensioners will not function again and must be replaced immediately. If the airbag and safety belt pretensioners are not replaced, the unrepaired area will increase the risk of injury in a collision.**

The SRS consists of:

- driver and passenger airbag modules (which include the inflators and airbags),
- one or more impact and safing sensors,
- a readiness light and tone

96



## Seating and Safety Restraints

- diagnostic module
- and the electrical wiring which connects the components.

The diagnostic module monitors its own internal circuits and the supplemental airbag electrical system wiring (including the impact sensors), the system wiring, the airbag system readiness light, the airbag back up power and the airbag ignitors.

### Front passenger sensing system

The front passenger sensing system will turn off the front passenger's frontal airbag under certain conditions. The front passenger seat-mounted side airbag (if equipped) will be deactivated if the sensor detects an empty seat; otherwise, the seat-mounted side airbag will be enabled. The front passenger sensing system works with sensors that are part of the front passenger's seat and safety belt. The sensors are designed to detect the presence of a properly-seated occupant and determine if the front passenger's frontal airbag should be enabled (may inflate) or not.

The front passenger sensing system is designed to meet the regulatory requirements of Federal Motor Vehicle Safety Standard (FMVSS) 208 and is designed to turn off the front passenger's frontal airbag if:

- the front passenger seat is unoccupied, or has small/medium objects in the front seat,
- the system determines that an infant is present in a rear-facing infant seat that is installed according to the manufacturer's instructions,
- the system determines that a small child is present in a forward-facing child restraint that is installed according to the manufacturer's instructions,
- the system determines that a small child is present in a booster seat,
- a front passenger takes his/her weight off of the seat for a period of time,
- A smaller person, such as a child who has outgrown child restraints, or a small adult occupies the front passenger seat.

**WARNING: Even with the front passenger sensing system, children 12 and under should be properly restrained in the back seat.**

## Seating and Safety Restraints

When the front passenger seat is occupied and the sensing system has turned off the passenger's frontal airbag, the "passenger airbag off" or "pass airbag off" indicator will light and stay lit to remind you that the front passenger frontal airbag is off. The indicator light will be unlit when:



- the front passenger seat is not occupied (empty seat),
- or in the event that the front passenger frontal airbag has been enabled (may inflate).

The indicator light is located in the center stack of the instrument panel just below the radio.

The front passenger sensing system is designed to turn off the front passenger's frontal airbag when a rear facing infant seat, a forward-facing child restraint, or a booster seat is detected. If the child restraint has been installed and the indicator is not lit - all the more important to put the child in the rear seat - if you insist on putting the child in the front seat against all advice, then turn the vehicle off, remove the child restraint from the vehicle and reinstall the restraint following the child restraint manufacturer's directions.

The front passenger sensing system is designed to enable (may inflate) the right front passenger's frontal airbag anytime the system senses that a person of adult size is sitting properly in the front passenger seat. When the passenger sensing system has allowed the airbag to be enabled, the indicator will be unlit and stay unlit to remind you that the airbag is enabled (may inflate).

If a person of adult-size is sitting in the front passenger's seat, but the "passenger airbag off" or "pass airbag off" indicator is lit, it could be that the person isn't sitting properly in the seat. If this happens, turn the vehicle off and ask the person to place the seatback in the full upright position, then sit upright in the seat, centered on the seat cushion, with the person's legs comfortably extended. Restart the vehicle and have the person remain in this position for about two minutes. This will allow the system to detect that person and then enable the passenger's airbag. If the indicator lamp remains lit even after this, then the occupant should be advised to ride in the back seat.

## Seating and Safety Restraints

After all occupants have adjusted their seats and put on seatbelts, it's very important that they continue to sit upright, with their back against the seatback, with their feet comfortably extended on the floor while the vehicle is still in motion. Sitting improperly can increase the chance of injury in a crash event. For example, if an occupant slouches, lies down, turns sideways, sits forward, leans forward or sideways, or puts one or both feet up, the chance of injury during a crash is greatly increased.

**WARNING: Sitting improperly out of position or with the seat back reclined too far can take off weight from the seat cushion and affect the decision of the passenger sensing system, resulting in serious injury or death in a crash. Always sit upright against your seatback, with your feet on the floor.**

The front passenger sensing system may detect small or medium objects placed on the seat cushion. For most objects that are in the front passenger seat, the passenger airbag will be disabled. Even though the passenger airbag is disabled, the "pass airbag off" light may or may not be illuminated according to the table below.

Objects	Pass Airbag Off Indicator Light	Passenger Airbag
Empty seat	Unlit	Disabled
Small (i.e. 3 ring binder, small purse, bottled water)	Unlit	Disabled
Medium (i.e. heavy briefcase, fully packed luggage)	Lit	Disabled
Empty seat, Small or medium object with safety belt buckled	Lit	Disabled

In case there is a problem with the passenger sensing system, the airbag readiness light in the instrument cluster will stay lit. DO NOT attempt to repair or service the system; take your vehicle immediately to the authorized Mazda dealer.

If it is necessary to modify an advanced front airbag system to accommodate a person with disabilities, contact the Mazda Customer Relationship Center at the phone number shown in the Customer Assistance section of this *Owner's Guide*.

## Seating and Safety Restraints

### Determining if the system is operational

The SRS uses a readiness light in the instrument cluster or a tone to indicate the condition of the system. Refer to the *Airbag readiness* section in the *Instrument Cluster* chapter. Routine maintenance of the airbag is not required.

A malfunction with the system is indicated by one or more of the following:

- The readiness light will either flash or stay lit.
- The readiness light will not illuminate immediately after ignition is turned on.
- A series of five beep sounds will be heard. The tone pattern will repeat periodically until the problem and/or light are repaired.



If any of these things happen, even intermittently, have the SRS serviced at your authorized Mazda dealership immediately.

**WARNING: Unless serviced, the system may not function properly in the event of a collision.**

### Side airbag system (if equipped)

**WARNING: Do not place objects or mount equipment on or near the airbag cover on the side of the seatbacks of the front seats or in front seat areas that may come into contact with a deploying airbag. Failure to follow these instructions may increase the risk of personal injury in the event of a collision.**

**WARNING: Do not use accessory seat covers. The use of accessory seat covers may prevent the deployment of the side airbags and increase the risk of injury in an accident.**

**WARNING: Do not lean your head on the door. The side airbag could injure you as it deploys from the side of the seatback.**

## Seating and Safety Restraints

**WARNING: Do not attempt to service, repair, or modify the airbag SRS, its fuses or the seat cover on a seat containing an airbag. See your Mazda dealer.**

**WARNING: All occupants of the vehicle should always wear their safety belts even when an airbag SRS is provided.**

### **How does the side airbag system work?**

The design and development of the side airbag system included recommended testing procedures that were developed by a group of automotive safety experts known as the Side Airbag Technical Working Group. These recommended testing procedures help reduce the risk of injuries related to the deployment of side airbags.

The side airbag system consists of the following:

- An inflatable nylon bag (airbag) with a gas generator concealed behind the outboard bolster of the driver and front passenger seatbacks.
- A special seat cover designed to allow airbag deployment.
- The same warning light, electronic control and diagnostic unit as used for the front airbags.
- Two crash sensors located on the lower portion of the b-pillar (one on each side of the vehicle).

Side airbags, in combination with safety belts, can help reduce the risk of severe injuries in the event of a significant side impact collision.

The side airbags are fitted on the outboard side of the seatbacks of the front seats. In certain lateral collisions, the airbag on the side affected by the collision will be inflated. If the front passenger sensing system detects an empty seat, the front passenger seat-mounted side airbag will be deactivated. The airbag was designed to inflate between the door panel and occupant to further enhance the protection provided occupants in side impact collisions.

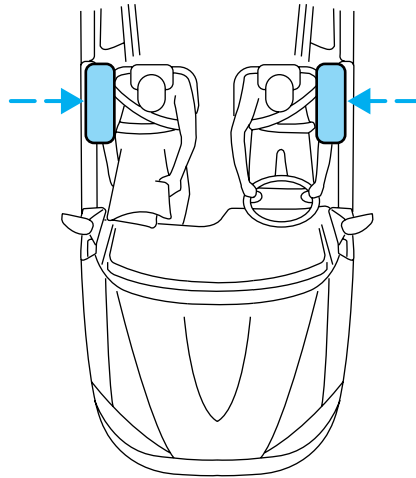

## Seating and Safety Restraints

The airbag SRS is designed to activate when the vehicle sustains lateral deceleration sufficient to cause the sensors to close an electrical circuit that initiates airbag inflation.

The fact that the airbags did not inflate in a collision does not mean that something is wrong with the system. Rather, it means the forces were not of the type sufficient to cause activation. Side airbags are designed to inflate in side-impact collisions, not roll-over, rear-impact, frontal or near-frontal collisions, unless the collision causes sufficient lateral deceleration.

**WARNING: Several air bag system components get hot after inflation. Do not touch them after inflation.**

**WARNING: If the side airbag has deployed, the airbag will not function again. The side airbag system (including the seat) must be inspected and serviced by a qualified technician in accordance with the vehicle service manual. If the airbag is not replaced, the unrepaired area will increase the risk of injury in a collision.**

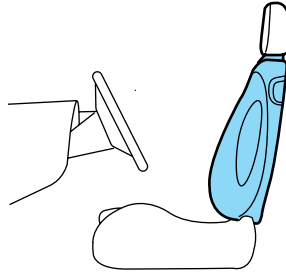

### ***Determining if the side airbags are operational***

First determine you have the optional side airbags - locate the "AIRBAG" labels on the outboard sides of the front seats.

The SRS uses a readiness light in the instrument cluster or a tone to indicate the condition of the system. Refer to the *Airbag readiness* section in the *Instrument cluster* chapter. Routine maintenance of the side airbag is not required.

A difficulty with the system is indicated by one or more of the following:

- The readiness light (same light as for front airbag system) will either flash or stay lit.
- The readiness light will not illuminate immediately after ignition is turned on.
- A series of five beeps will be heard. The tone pattern will repeat periodically until the problem and/or light are repaired.

## Seating and Safety Restraints

If any of these things happen, even intermittently, have the SRS serviced by your authorized Mazda dealership immediately. Unless serviced, the system may not function properly in the event of a collision.

### Side-curtain airbag system (if equipped)

You can easily confirm if your vehicle has side-curtain airbags by looking inside the vehicle up at the upper "B" pillar where you will see an embossed "AIRBAG" label.

**WARNING: Do not place objects or mount equipment on or near the headliner at the siderail that may come into contact with a deploying side-curtain airbags (if equipped). Failure to follow these instructions may increase the risk of personal injury in the event of a collision.**

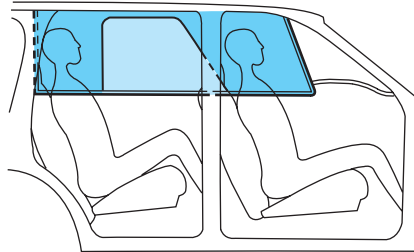

**WARNING: Do not lean your head on the door or window glass. The side-curtain airbags (if equipped) could injure you as it deploys from the headliner.**

**WARNING: Do not attempt to service, repair, or modify the side-curtain airbags (if equipped), fuses, the A, B, or C pillar trim, or the headliner on a vehicle containing side-curtain airbags. See your authorized Mazda dealer.**

**WARNING: All occupants of the vehicle including the driver should always wear their safety belts even when an airbag SRS and side-curtain airbags (if equipped) are provided.**

## Seating and Safety Restraints

**WARNING: To reduce risk of injury, do not obstruct or place objects in the deployment path of the inflatable side-curtain airbags (if equipped).**

### **How do the side-curtain airbags (if equipped) work?**

The side-curtain airbags (if equipped) consists of the following:

- An inflatable nylon curtain with a gas generator concealed behind the headliner and above the doors (one on each side of vehicle).
- A headliner designed to flex open above the side doors to allow side-curtain airbag deployment.
- The same warning light, electronic control and diagnostic unit as used for the front airbags.
- Two crash sensors mounted at lower B-Pillar (one on each side).
- Two crash sensors located at the c-pillar behind the rear doors (one on each side).
- Rollover sensor in the restraints control module (RCM).

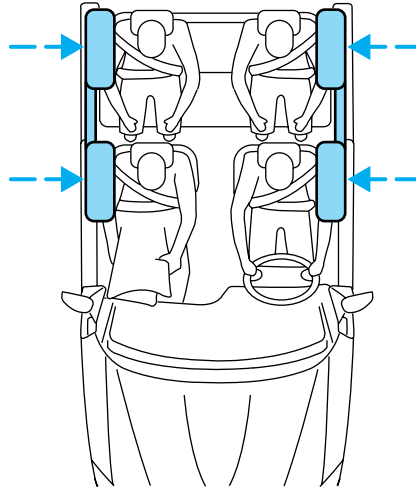

The side-curtain airbags (if equipped), in combination with safety belts, can help reduce the risk of severe injuries in the event of a significant side impact collision or rollover event.

Children 12 years old and under should always be properly restrained in the rear seats. The side-curtain airbags (if equipped) will not interfere with children restrained using a properly installed child or booster seat because it is designed to inflate downward from the headliner above the doors along the side window opening.

The side-curtain airbags (if equipped) are designed to activate when the vehicle sustains lateral deceleration sufficient to cause the RCM to initiate side-curtain airbag (if equipped) inflation or when a certain likelihood of a rollover event is detected by the rollover sensor.



## Seating and Safety Restraints

The side-curtain airbags are mounted to roof side-rail sheet metal, behind the headliner, above the first and second row seats. In certain lateral collisions or rollover events, the side-curtain airbags will be activated, regardless of which seats are occupied. In certain rollover events, the side-curtain airbag (if equipped) on both sides of the vehicle will be inflated, regardless of which seats are occupied. The side-curtain airbags (if equipped) are designed to inflate between the side window area and occupants to further enhance protection provided in side impact collisions and rollover events.

The fact that the side-curtain airbags (if equipped) did not activate in a collision does not mean that there is a malfunction with the system. Rather, it means the forces were not of the type sufficient to cause activation. The side-curtain airbags (if equipped) are designed to inflate in certain side impact collisions or rollover events, not in rear impact, frontal or near-frontal collisions, unless the collision causes sufficient lateral deceleration or rollover likelihood.

**WARNING: Several side-curtain airbag (if equipped) components get hot after inflation. Do not touch them after inflation.**

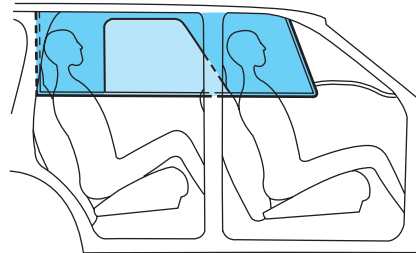

**WARNING: If the side-curtain airbags (if equipped) have deployed, the side-curtain airbags will not function again unless replaced. The side-curtain airbags (including the A, B and C pillar trim) must be inspected and serviced by a qualified technician in accordance with the vehicle workshop manual. If the side-curtain airbags are not replaced, the unrepaired area will increase the risk of injury in a collision.**

## Seating and Safety Restraints

### ***Determining if the side-curtain airbags are operational***

The SRS uses a readiness light in the instrument cluster or a tone to indicate the condition of the system. Refer to the *Airbag readiness* section in the *Instrument cluster* chapter. Routine maintenance of the airbag is not required.

A difficulty with the system is indicated by one or more of the following:

- The readiness light (same light as for front airbag system) will either flash or stay lit.
- The readiness light will not illuminate immediately after ignition is turned on.
- A series of five beep sounds will be heard. The tone pattern will repeat periodically until the problem and light are repaired.

If any of these things happen, even intermittently, have the SRS serviced at your authorized Mazda dealership immediately. Unless serviced, the system may not function properly in the event of a collision.

### **Disposal of airbags and airbag equipped vehicles**

For disposal of safety belt pretensioners, airbags, or airbag equipped vehicles, see your authorized Mazda dealership. Airbags **MUST BE** disposed of by qualified personnel.

**WARNING: Disposing of an airbag can be dangerous. Unless all safety procedures are followed, injury can result. Ask an Authorized Mazda dealer how to safely dispose of an airbag or how to scrap an airbag equipped vehicle.**

## **SAFETY RESTRAINTS FOR CHILDREN**

See the following sections for directions on how to properly use safety restraints for children. Also see *Airbag supplemental restraint system (SRS)* in this chapter for special instructions about using airbags.

### **Important child restraint precautions**

**NOTE:** You are required to use safety restraints for children in the U.S. and Canada. Check your local and state or provincial laws for specific requirements regarding the safety of children in your vehicle.

**WARNING: Never let a passenger hold a child on his or her lap while the vehicle is moving. The passenger cannot protect the child from injury in a collision.**

## Seating and Safety Restraints

**NOTE:** Always follow the instructions and warnings that come with any infant or child restraint you might use.

**WARNING: When possible, always place children under age 12 in the rear seat of your vehicle. Accident statistics suggest that children are safer when properly restrained in the rear seating positions than in the front seating position.**

### Children and safety belts

If the child is the proper size, restrain the child in a safety seat.

Children who are too large for child safety seats (as specified by your child safety seat manufacturer) should always wear safety belts.

Follow all the important safety restraint and airbag precautions that apply to adult passengers in your vehicle.

If the shoulder belt portion of a combination lap and shoulder belt can be positioned so it does not cross or rest in front of the child's face or neck, the child should wear the lap and shoulder belt. Moving the child closer to the center of the vehicle may help provide a good shoulder belt fit.

**WARNING: Do not leave children, unreliable adults, or pets unattended in your vehicle.**

**WARNING: Placing a child, 12 years or younger, in the front seat is dangerous. The child could be hit by a deploying airbag and be seriously injured or even killed. A sleeping child is more likely to lean against the door and be hit by the side airbag in a moderate collision. Whenever possible, always secure a child, 12 years or younger, in the rear seat, with an appropriate child restraint system for the child's age and size. Never use a rear-facing child restraint system in the front seat with an airbag that could deploy.**

## Seating and Safety Restraints

### Child booster seats

Children outgrow a typical convertible or toddler seat when they weigh 40 pounds and are around 4 years of age. Although the lap/shoulder belt will provide some protection, these children are still too small for lap/shoulder belts to fit properly, which could increase the risk of serious injury.

To improve the fit of both the lap and shoulder belt on children who have outgrown child safety seats, Mazda recommends use of a belt-positioning booster seat.

Booster seats position a child so that safety belts fit better. They lift the child up so that the lap belt rests low across the hips and the knees bend comfortably. Booster seats also make the shoulder belt fit better and more comfortably for growing children.

### When children should use booster seats

Children need to use booster seats from the time they outgrow the toddler seat until they are big enough for the vehicle seat and lap/shoulder belt to fit properly. Generally this is when they weigh about 80 lb. (about 8 to 12 years old).

Booster seats should be used until you can answer YES to ALL of these questions:

- Can the child sit all the way back against the vehicle seat back with knees bent comfortably at the edge of the seat without slouching?

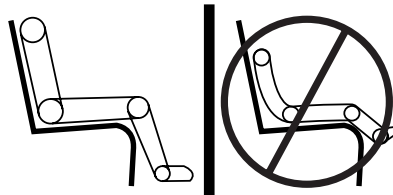

- Does the lap belt rest low across the hips?
- Is the shoulder belt centered on the shoulder and chest?
- Can the child stay seated like this for the whole trip?

**WARNING: Booster seats must be installed only in seating positions equipped with a combination lap/shoulder belt.**

## Seating and Safety Restraints

### Types of booster seats

There are two types of belt-positioning booster seats:

- Those that are backless.

If your backless booster seat has a removable shield, remove the shield and use the lap/shoulder belt. If a seating position has a low seat back and no head restraint, a backless booster seat may place your child's head (top of ear level) above the top of the seat. In this case, use a high-backed booster seat.



- Those with a high back.

If, with a backless booster seat, you cannot find a seating position that adequately supports your child's head, a high back booster seat would be a better choice.



Both can be used in any vehicle in a seating position equipped with lap/shoulder belts if your child is over 40 lb..

The shoulder belt should cross the chest, resting snugly on the center of the shoulder. The lap belt should rest low and snug across the hips, never up high across the stomach.

If the booster seat slides on the vehicle seat, placing a rubberized mesh sold as shelf or carpet liner under the booster seat may improve this condition.

### The importance of shoulder belts

Using a booster without a shoulder belt increases the risk of a child's head hitting a hard surface in a collision. For this reason, you should never use a booster seat with a lap belt only. It is best to use a booster seat with lap/shoulder belts in the back seat- the safest place for children to ride.

## Seating and Safety Restraints

**WARNING:** Follow all instructions provided by the manufacturer of the booster seat.

**WARNING:** Never put the shoulder belt under a child's arm or behind the back because it eliminates the protection for the upper part of the body and may increase the risk of injury or death in a collision.

**WARNING:** Never use pillows, books, or towels to boost a child. They can slide around and increase the likelihood of injury or death in a collision.

### SAFETY SEATS FOR CHILDREN

#### Child and infant or child safety seats

Use a safety seat that is recommended for the size and weight of the child. Carefully follow all of the manufacturer's instructions with the safety seat you put in your vehicle. If you do not install and use the safety seat properly, the child may be injured in a sudden stop or collision.

When installing a child safety seat:

- Review and follow the information presented in the *Airbag Supplemental Restraint System* section in this chapter.
- Use the correct safety belt buckle for that seating position (the buckle closest to the direction the tongue is coming from).
- Insert the belt tongue into the proper buckle until you hear a snap and feel it latch. Make sure the tongue is securely fastened in the buckle.
- Keep the buckle release button pointing up and away from the safety seat, with the tongue between the child seat and the release button, to prevent accidental unbuckling.
- Place seat back in upright position.

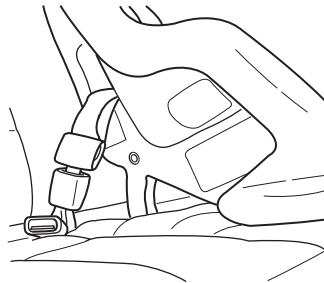

## Seating and Safety Restraints

- Put the safety belt in the automatic locking mode. Refer to *Automatic locking mode*.

Mazda recommends the use of a child safety seat having a top tether strap. Install the child safety seat in a seating position which is capable of providing a tether anchorage. For more information on top tether straps, refer to *Attaching child safety seats with tether straps*.

**WARNING: Carefully follow all of the manufacturer's instructions included with the safety seat you put in your vehicle. If you do not install and use the safety seat properly, the child may be injured in a sudden stop or collision.**

**The rear seat head restraints must be removed when using a child seat.**

**WARNING: Air bags can kill or injure a child in a child seat. NEVER place a rear-facing child seat in front of an active air bag. If you must use a forward-facing child seat in the front seat, move the seat all the way back.**

1. Position the child safety seat in a seat with a combination lap and shoulder belt.

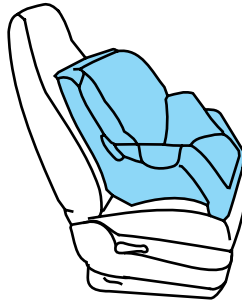

**WARNING: Children 12 and under should be properly restrained in the rear seat whenever possible.**

## Seating and Safety Restraints

2. Pull down on the shoulder belt and then grasp the shoulder belt and lap belt together.

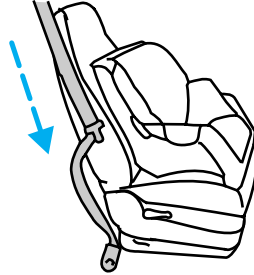

3. While holding the shoulder and lap belt portions together, route the tongue through the child seat according to the child seat manufacturer's instructions. Be sure the belt webbing is not twisted.

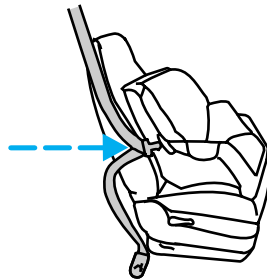

4. Insert the belt tongue into the proper buckle (the buckle closest to the direction the tongue is coming from) for that seating position until you hear a snap and feel the latch engage. Make sure the tongue is latched securely by pulling on it.

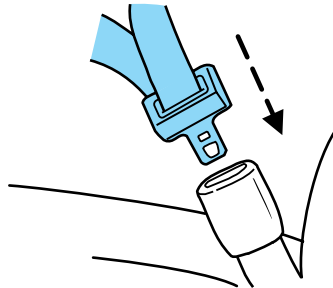



## Seating and Safety Restraints

5. To put the retractor in the automatic locking mode, grasp the shoulder portion of the belt and pull downward until all of the belt is extracted and a click is heard.

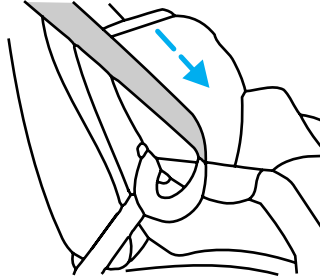

6. Allow the belt to retract. The belt will click as it retracts to indicate it is in the automatic locking mode.
7. Pull the lap belt portion across the child seat toward the buckle and pull up on the shoulder belt while pushing down with your knee on the child seat.

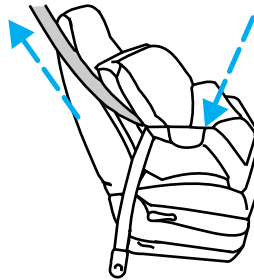

8. Allow the safety belt to retract to remove any slack in the belt.
9. Before placing the child in the seat, forcibly tilt the seat forward and back to make sure the seat is securely held in place. To check this, grab the seat at the belt path and attempt to move it side to side and forward and back. There should be no more than one inch of movement for proper installation.
10. Try to pull the belt out of the retractor to make sure the retractor is in the automatic locking mode (you should not be able to pull more belt out). If the retractor is not locked, unbuckle the belt and repeat Steps two through nine.

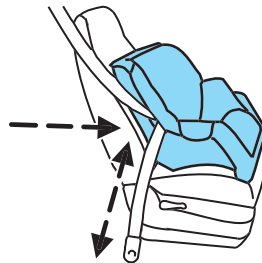

Check to make sure the child seat is properly secured before each use.

## Seating and Safety Restraints

### Attaching child safety seats with tether straps

Most new forward-facing child safety seats include a tether strap which goes over the back of the seat and hooks to an anchoring point. Tether straps are available as an accessory for many older safety seats. Contact the manufacturer of your child seat for information about ordering a tether strap.

The rear seating positions of your vehicle are equipped with built-in tether strap anchors located behind the seats as described below.

The tether anchors in your vehicle are located on the roof panel in the cargo area.

The tether strap anchors in your vehicle are in the following positions:

**WARNING: Attach the tether strap only to the appropriate tether anchor as shown. The tether strap may not work properly if attached somewhere other than the correct tether anchor.**

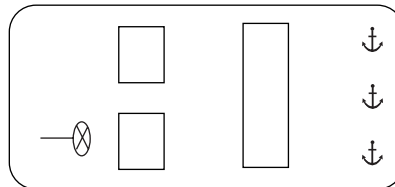

1. Position the child safety seat on the passenger seat cushion.
2. Route the child safety seat tether strap over the back of the seat.

**NOTE:** For vehicles with adjustable head restraints, route the tether strap under the head restraint and between the head restraint posts, otherwise route the tether strap over the top of the seatback.

**NOTE:** For vehicles with adjustable head restraints, route the tether strap over the top of the seatback.

## Seating and Safety Restraints

3. Locate the correct anchor for the selected seating position.

**NOTE:** There are three tether anchors located on the headliner at the rear of the vehicle.

**WARNING:** If the tether strap is clipped incorrectly, the child safety seat may not be retained properly in the event of a collision. If the safety seat is not anchored properly, the risk of a child being injured in a collision greatly increases.

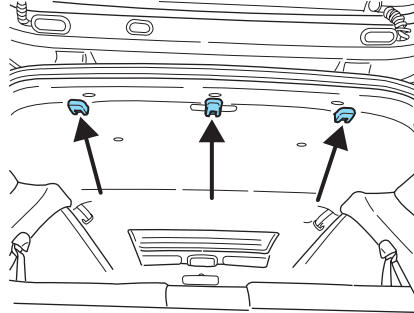

4. Clip the tether strap to the anchor as shown.

The arrow in the above graphic points toward the front of the vehicle.

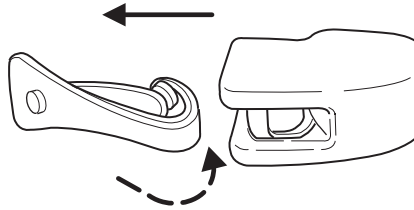

5. Refer to the *Installing child safety seats in combination lap and shoulder belt seating positions* section of this chapter for further instructions to secure the child safety seat.
6. Tighten the child safety seat tether strap according to the manufacturer's instructions.

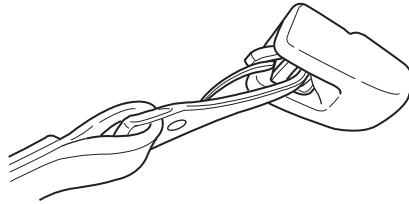

## Seating and Safety Restraints

### Attaching safety seats with LATCH (Lower Anchors and Tethers for Children) attachments for child seat anchors

Some child safety seats have two rigid or webbing mounted attachments that connect to two anchors at certain seating positions in your vehicle. When properly installed, this type of seat eliminates the need to use safety belts to attach the child seat. For forward-facing child seats, the tether strap must also be attached to the proper tether anchor. See *Attaching safety seats with tether straps* in this chapter.

Your vehicle has LATCH anchors for child seat installation as shown in the illustration. There are none in the front passenger seat.

The anchors closest to the center rear seat are provided primarily for child seats at the outboard seating positions. These anchors are farther apart than the pairs of lower anchors for child seat installation at the outboard seats.

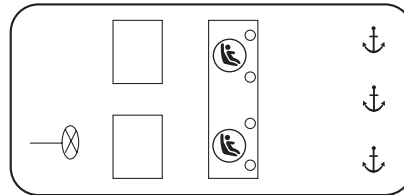

While the anchors closest to the center seat may also be usable, special precautions must be followed. First, if those anchors are already in use by a LATCH equipped child seat on either outboard seat, **you must not attach two LATCH seats to the same anchor point** — it will overload the anchor point. Either spread the two LATCH equipped seats to the outboard positions or use the regular lap belt on the center one (If the seat has a tether, be sure to also attach it to the center tether anchor).

Secondly, those LATCH equipped child seats **with rigid LATCH attachments** will not latch in the center rear position because those two middle anchors are too far apart. You can only attach the rigid LATCH equipped child seats to the outboard seat LATCH anchors that have the proper spacing for that type of child seat. If your child seat has flexible LATCH attachments, be sure that the manufacturer's instructions say that it can reach to anchors spaced at least 500 mm (19 in) apart.

**WARNING: Never attach two LATCH child safety seats to the same anchor. In a crash, one anchor may not be strong enough to hold two child safety seat attachments and may break, causing serious injury or death.**

## Seating and Safety Restraints

The lower anchors for child seat installation are located at the rear section of the rear seat between the cushion and seat back.

The LATCH anchors are below the locator symbols on the seatback.

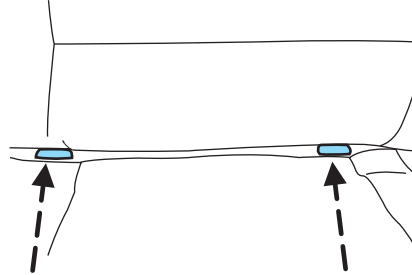

Follow the child seat manufacturer's instructions to properly install a child seat with LATCH attachments.

**WARNING: Attach LATCH lower attachments of the child seat only to the anchors shown.**

If you install a child seat with rigid LATCH attachments, do not tighten the tether strap enough to lift the child seat off the vehicle seat cushion when the child is seated in it. Keep the tether strap just snug without lifting the front of the child seat. Keeping the child seat just touching the vehicle seat gives the best protection in a severe crash.

Each time you use the safety seat, check that the seat is properly attached to the lower anchors and tether anchor. Try to tilt the child seat from side to side. Also try to tug the seat forward. Check to see if the anchors hold the seat in place.

**WARNING: If the safety seat is not anchored properly, the risk of a child being injured in a crash greatly increases.**

## Tires, Wheels and Loading

### NOTICE TO UTILITY VEHICLE AND TRUCK OWNERS

Utility vehicles and trucks handle differently than passenger cars in the various driving conditions that are encountered on streets, highways and off-road. Utility vehicles and trucks are not designed for cornering at speeds as high as passenger cars any more than low-slung sports cars are designed to perform satisfactorily under off-road conditions.

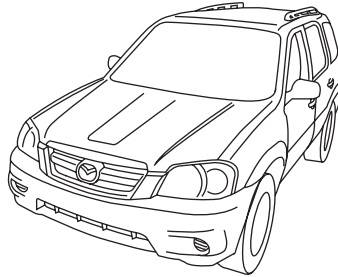

**WARNING: Utility vehicles have a significantly higher rollover rate than other types of vehicles. To reduce the risk of serious injury or death from a rollover or other crash you must:**

- Avoid sharp turns and abrupt maneuvers;
- Drive at safe speeds for the conditions;
- Keep tires properly inflated;
- Never overload or improperly load your vehicle; and
- Make sure every passenger is properly restrained.

**WARNING: In a rollover crash, an unbelted person is significantly more likely to die than a person wearing a seat belt. All occupants must wear safety belts and children/infants must use appropriate restraints to minimize the risk of injury or ejection.**

Study your *Owner's Guide* and any supplements for specific information about equipment features, instructions for safe driving and additional precautions to reduce the risk of an accident or serious injury.

### VEHICLE CHARACTERISTICS

#### 4WD and AWD Systems (if equipped)

A vehicle equipped with AWD or 4WD (when selected) has the ability to use all four wheels to power itself. This increases traction which may enable you to safely drive over terrain and road conditions that a conventional two-wheel drive vehicle cannot.

## Tires, Wheels and Loading

Power is supplied to all four wheels through a transfer case or power transfer unit. 4WD vehicles allow you to select different drive modes as necessary. Information on transfer case operation and shifting procedures can be found in the *Driving* chapter. Information on transfer case maintenance can be found in the *Maintenance and Specification* chapter. You should become thoroughly familiar with this information before you operate your vehicle.

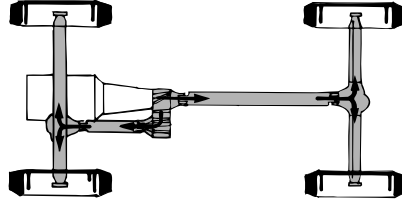

On some 4WD models, the initial shift from two-wheel drive to 4WD while the vehicle is moving can cause a momentary clunk and ratcheting sound. These sounds are normal as the front drivetrain comes up to speed and is not cause for concern.

**WARNING: Do not become overconfident in the ability of 4WD and AWD vehicles. Although a 4WD or AWD vehicle may accelerate better than two-wheel drive vehicle in low traction situations, it won't stop any faster than two-wheel drive vehicles. Always drive at a safe speed.**

### How your vehicle differs from other vehicles

SUV and trucks can differ from some other vehicles in a few noticeable ways. Your vehicle may be:

- Higher – to allow higher load carrying capacity and to allow it to travel over rough terrain without getting hung up or damaging underbody components.
- Shorter – to give it the capability to approach inclines and drive over the crest of a hill without getting hung up or damaging underbody components. All other things held equal, a shorter wheelbase may make your vehicle quicker to respond to steering inputs than a vehicle with a longer wheelbase.

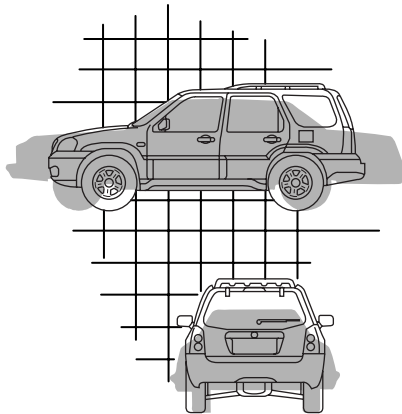

## Tires, Wheels and Loading

- Narrower — to provide greater maneuverability in tight spaces, particularly in off-road use.

As a result of the above dimensional differences, SUV's and trucks often will have a higher center of gravity and a greater difference in center of gravity between the loaded and unloaded condition.

These differences that make your vehicle so versatile also make it handle differently than an ordinary passenger car.

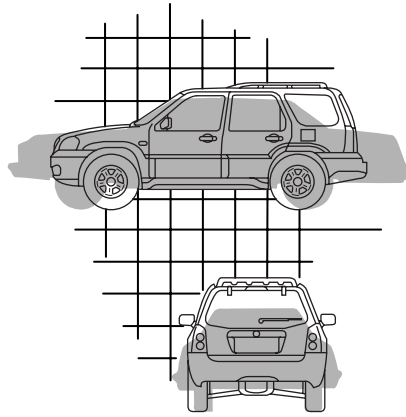

### INFORMATION ABOUT UNIFORM TIRE QUALITY GRADING

New vehicles are fitted with tires that have a rating on them called Tire Quality Grades. The Quality grades can be found where applicable on the tire sidewall between tread shoulder and maximum section width. For example:

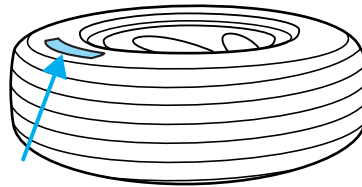

- **Treadwear 200 Traction AA Temperature A**

These Tire Quality Grades are determined by standards that the United States Department of Transportation has set.

Tire Quality Grades apply to new pneumatic tires for use on passenger cars. They do not apply to deep tread, winter-type snow tires, space-saver or temporary use spare tires, tires with nominal rim diameters of 10 to 12 inches or limited production tires as defined in Title 49 Code of Federal Regulations Part 575.104(c)(2).

**U.S. Department of Transportation-Tire quality grades:** The U.S. Department of Transportation requires Mazda to give you the following information about tire grades exactly as the government has written it.



## Tires, Wheels and Loading

### Treadwear

The treadwear grade is a comparative rating based on the wear rate of the tire when tested under controlled conditions on a specified government test course. For example, a tire graded 150 would wear one and one-half (1 1/2) times as well on the government course as a tire graded 100. The relative performance of tires depends upon the actual conditions of their use, however, and may depart significantly from the norm due to variations in driving habits, service practices, and differences in road characteristics and climate.

### Traction AA A B C

The traction grades, from highest to lowest are AA, A, B, and C. The grades represent the tire's ability to stop on wet pavement as measured under controlled conditions on specified government test surfaces of asphalt and concrete. A tire marked C may have poor traction performance.

**NOTE:** The traction grade assigned to this tire is based on straight-ahead braking traction tests, and does not include acceleration, cornering, hydroplaning or peak traction characteristics.

### Temperature A B C

The temperature grades are A (the highest), B, and C, representing the tire's resistance to the generation of heat and its ability to dissipate heat when tested under controlled conditions on a specified indoor laboratory test wheel. Sustained high temperature can cause the material of the tire to degenerate and reduce tire life, and excessive temperature can lead to sudden tire failure. The grade C corresponds to a level of performance which all passenger car tires must meet under the Federal Motor Vehicle Safety Standard No. 109. Grades B and A represent higher levels of performance on the laboratory test wheel than the minimum required by law.

**WARNING: The temperature grade for this tire is established for a tire that is properly inflated and not overloaded. Excessive speed, underinflation, or excessive loading, either separately or in combination, can cause heat buildup and possible tire failure.**

## Tires, Wheels and Loading

### TIRES

Tires are designed to give many thousands of miles of service, but they must be maintained in order to get the maximum benefit from them.

#### Glossary of tire terminology

- **Safety Compliance Certification Label:** A label showing the OE (Original Equipment) tire sizes, recommended inflation pressure and the maximum weight the vehicle can carry.
- **Tire Identification Number (TIN):** A number on the sidewall of each tire providing information about the tire brand and manufacturing plant, tire size and date of manufacture.
- **Inflation pressure:** A measure of the amount of air in a tire.
- **Standard load:** A class of P-metric or Metric tires designed to carry a maximum load at 35 psi [37 psi (2.5 bar) for Metric tires]. Increasing the inflation pressure beyond this pressure will not increase the tire's load carrying capability.
- **Extra load:** A class of P-metric or Metric tires designed to carry a heavier maximum load at 41 psi [43 psi (2.9 bar) for Metric tires]. Increasing the inflation pressure beyond this pressure will not increase the tire's load carrying capability.
- **kPa:** Kilopascal, a metric unit of air pressure.
- **PSI:** Pounds per square inch, a standard unit of air pressure.
- **Cold inflation pressure:** The tire pressure when the vehicle has been stationary and out of direct sunlight for an hour or more and prior to the vehicle being driven for 1 mile (1.6 km).
- **Recommended inflation pressure:** The cold inflation pressure found on the Safety Compliance Certification Label located on the B-Pillar or the edge of the driver's door.
- **B-pillar:** The structural member at the side of the vehicle behind the front door.
- **Bead area of the tire:** Area of the tire next to the rim.
- **Sidewall of the tire:** Area between the bead area and the tread.
- **Tread area of the tire:** Area of the perimeter of the tire that contacts the road when mounted on the vehicle.
- **Rim:** The metal support (wheel) for a tire or a tire and tube assembly upon which the tire beads are seated.

## Tires, Wheels and Loading

### INSPECTING AND INFLATING YOUR TIRES

Safe operation of your vehicle requires that your tires are properly inflated. Remember that a tire can lose up to half of its air pressure without appearing flat.

Every day before you drive, check your tires. If one looks lower than the others, use a tire gauge to check pressure of all tires and adjust if required.

At least once a month and before long trips, inspect each tire and check the tire pressure with a tire gauge (including spare, if equipped). Inflate all tires to the inflation pressure recommended by Mazda.

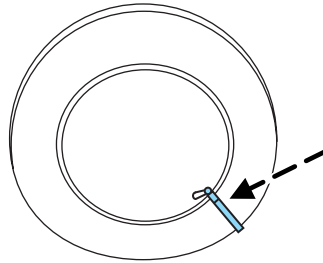

### Inflating your tires

Use a tire gauge to check the tire inflation pressure, including the spare (if equipped), at least monthly and before long trips. You are strongly urged to buy a reliable tire pressure gauge, as automatic service station gauges may be inaccurate. Mazda recommends the use of a digital or dial type tire pressure gauge rather than a stick type tire pressure gauge.

Use the recommended cold inflation pressure for optimum tire performance and wear. Under-inflation or over-inflation may cause uneven treadwear patterns.

**NOTE:** If you are driving the vehicle at its maximum weight load, make sure the tire inflation pressure is correct for the weight load on the tires.

**WARNING: Under-inflation is the most common cause of tire failures and may result in severe tire cracking, tread separation or "blowout", with unexpected loss of vehicle control and increased risk of injury. Under-inflation increases sidewall flexing and rolling resistance, resulting in heat buildup and internal damage to the tire. It also may result in unnecessary tire stress, irregular wear, loss of vehicle control and accidents. A tire can lose up to half of its air pressure and not appear to be flat!**

Always inflate your tires to the Mazda recommended inflation pressure even if it is less than the maximum inflation pressure information found

## Tires, Wheels and Loading

on the tire. The Mazda recommended tire inflation pressure is found on the Safety Compliance Certification Label which is on the B-Pillar or the edge of the driver's door. Failure to follow the tire pressure recommendations can cause uneven treadwear patterns and adversely affect the way your vehicle handles.

**Maximum Permissible Inflation Pressure** is the tire manufacturer's maximum permissible pressure and/or the pressure at which the maximum load can be carried by the tire. This pressure is normally higher than the manufacturer's recommended cold inflation pressure which can be found on either the Safety Compliance Certification Label which is located on the structure by the trailing edge of the driver's door or the edge of the driver's door. The cold inflation pressure should never be set lower than the recommended pressure on the Safety Compliance Certification Label.

When weather temperature changes occur, tire inflation pressures also change. A 10° F (6° C) temperature drop causes a corresponding drop of 1 psi (7 kPa) in inflation pressure. Check your tire pressures frequently and adjust them to the proper pressure which can be found on the Safety Compliance Certification Label.

If checking tire pressure when the tire is hot, (i.e. driven more than 1 mile [1.6 km]), never "bleed" or reduce air pressure. The tires are hot from driving and it is normal for pressures to increase above recommended cold pressures. A hot tire at or below recommended cold inflation pressure could be significantly under-inflated.

To check the pressure in your tire(s):

1. Make sure the tires are cool, meaning they are not hot from driving even a mile.

**Note:** If you have to drive a distance to get air for your tire(s), check and record the tire pressure first and add the appropriate air pressure when you get to the pump. It is normal for tires to heat up and the air pressure inside to go up as you drive. Never "bleed" or reduce air pressure when tires are hot.

2. Remove the cap from the valve on one tire, then firmly press the tire gauge onto the valve and measure the pressure.
3. Add enough air to reach the recommended air pressure

**Note:** If you overfill the tire, release air by pushing on the metal stem in the center of the valve. Then recheck the pressure with your tire gauge.

4. Replace the valve cap.
5. Repeat this procedure for each tire, including the spare.

## Tires, Wheels and Loading

**Note:** Some spare tires operate at a higher inflation pressure than the other tires. For T-type/mini-spare tires (see *T-Type/Mini-Spare Tire Information* section for description): Store and maintain at 60psi (4.15 bars). For Full Size and Dissimilar spare tires (see *Dissimilar Spare Tire/Wheel Information* section for description): Store and maintain at the higher of the front and rear inflation pressure as shown on the Safety Compliance Certification Label.

6. Visually inspect the tires to make sure there are no nails or other objects embedded that could poke a hole in the tire and cause an air leak.
7. Check the sidewalls to make sure there are no gouges, cuts or bulges.

### TIRE REPLACEMENT REQUIREMENTS

Your vehicle is equipped with tires designed to provide a safe ride and handling capability.

**WARNING: Only use replacement tires and wheels that are the same size and type (such as P-metric versus LT-metric or all-season versus all-terrain) as those originally provided by Mazda. Use of any tire or wheel not recommended by Mazda can affect the safety and performance of your vehicle, which could result in an increased risk of loss of vehicle control, vehicle rollover, personal injury and death. Additionally the use of non-recommended tires and wheels could cause steering, suspension, axle or transfer case/power transfer unit failure. If you have questions regarding tire replacement, see an authorized Mazda dealer.**

Make sure all tires and wheels on the vehicle are of the same size, type, tread design, brand, load-carrying capacity and speed rating because it can affect the safety and performance of your vehicle, which could result in an increased risk of loss of vehicle control, vehicle rollover, personal injury and death.

**Important:** Remember to replace the spare tire when you replace the road tires on your vehicle. Even if it has never been used, the spare tire should be replaced because tires degrade over time.

**Important:** Remember to replace the wheel air valves when the road tires are replaced on your vehicle.

## Tires, Wheels and Loading

### INFORMATION CONTAINED ON THE TIRE SIDEWALL

Federal law requires tire manufacturers to place standardized information on the sidewall of all tires. This information identifies and describes the fundamental characteristics of the tire and also provides a U.S. DOT Tire Identification Number for safety standard certification and in case of a recall.

#### Information on “P” type tires

P215/65R15 95H is an example of a tire size, load index and speed rating. The definitions of these items are listed below. (Note that the tire size, load index and speed rating for your vehicle may be different from this example.)

1. **P:** Indicates a tire, designated by the Tire and Rim Association (T&RA), that may be used for service on cars, SUVs, minivans and light trucks.

**Note:** If your tire size does not begin with a letter this may mean it is designated by either ETRTO (European Tire and Rim Technical Organization) or JATMA (Japan Tire Manufacturing Association).

2. **215:** Indicates the nominal width of the tire in millimeters from sidewall edge to sidewall edge. In general, the larger the number, the wider the tire.
3. **65:** Indicates the aspect ratio which gives the tire’s ratio of height to width.
4. **R:** Indicates a “radial” type tire.
5. **15:** Indicates the wheel or rim diameter in inches. If you change your wheel size, you will have to purchase new tires to match the new wheel diameter.
6. **95:** Indicates the tire’s load index. It is an index that relates to how much weight a tire can carry. You may find this information in your *Owner’s Guide*. If not, contact a local tire dealer.

**Note:** You may not find this information on all tires because it is not required by federal law.

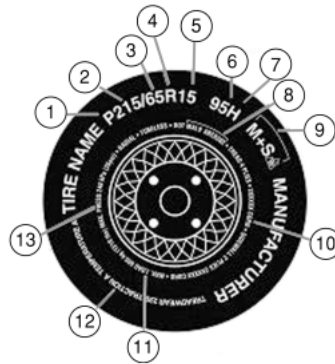

## Tires, Wheels and Loading

7. **H:** Indicates the tire's speed rating. The speed rating denotes the speed at which a tire is designed to be driven for extended periods of time under a standard condition of load and inflation pressure. The tires on your vehicle may operate at different conditions for load and inflation pressure. These speed ratings may need to be adjusted for the difference in conditions. The ratings range from 81 mph (130 km/h) to 186 mph (299 km/h). These ratings are listed in the following chart.

**Note:** You may not find this information on all tires because it is not required by federal law.

Letter rating	Speed rating - mph (km/h)
M	81 mph (130 km/h)
N	87 mph (140 km/h)
Q	99 mph (159 km/h)
R	106 mph (171 km/h)
S	112 mph (180 km/h)
T	118 mph (190 km/h)
U	124 mph (200 km/h)
H	130 mph (210 km/h)
V	149 mph (240 km/h)
W	168 mph (270 km/h)
Y	186 mph (299 km/h)

**Note:** For tires with a maximum speed capability over 149 mph (240 km/h), tire manufacturers sometimes use the letters ZR. For those with a maximum speed capability over 186 mph (299 km/h), tire manufacturers always use the letters ZR.

8. **U.S. DOT Tire Identification Number (TIN):** This begins with the letters "DOT" and indicates that the tire meets all federal standards. The next two numbers or letters are the plant code designating where it was manufactured, the next two are the tire size code and the last four numbers represent the week and year the tire was built. For example, the numbers 317 mean the 31st week of 1997. After 2000 the numbers go to four digits. For example, 2501 means the 25th week of 2001. The numbers in between are identification codes used for traceability. This information is used to contact customers if a tire defect requires a recall.

## Tires, Wheels and Loading

9. **M+S or M/S:** Mud and Snow, or  
**AT:** All Terrain, or  
**AS:** All Season.
10. **Tire Ply Composition and Material Used:** Indicates the number of plies or the number of layers of rubber-coated fabric in the tire tread and sidewall. Tire manufacturers also must indicate the ply materials in the tire and the sidewall, which include steel, nylon, polyester, and others.
11. **Maximum Load:** Indicates the maximum load in kilograms and pounds that can be carried by the tire. Refer to the Safety Compliance Certification Label, which is located on the B-Pillar or the edge of the driver's door, for the correct tire pressure for your vehicle.
12. **Treadwear, Traction and Temperature Grades**
  - **Treadwear:** The treadwear grade is a comparative rating based on the wear rate of the tire when tested under controlled conditions on a specified government test course. For example, a tire graded 150 would wear one and one-half (1½) times as well on the government course as a tire graded 100.
  - **Traction:** The traction grades, from highest to lowest are AA, A, B, and C. The grades represent the tire's ability to stop on wet pavement as measured under controlled conditions on specified government test surfaces of asphalt and concrete. A tire marked C may have poor traction performance.
  - **Temperature:** The temperature grades are A (the highest), B and C, representing the tire's resistance to the generation of heat and its ability to dissipate heat when tested under controlled conditions on a specified indoor laboratory test wheel.
13. **Maximum Permissible Inflation Pressure:** Indicates the tire manufacturers' maximum permissible pressure and/or the pressure at which the maximum load can be carried by the tire. This pressure is normally higher than the manufacturer's recommended cold inflation pressure which can be found on either the Safety Compliance Certification Label which is located on the B-Pillar or the edge of the driver's door. The cold inflation pressure should never be set lower than the recommended pressure on the vehicle label.

The tire suppliers may have additional markings, notes or warnings such as standard load, radial tubeless, etc.

128



## Tires, Wheels and Loading

### Additional information contained on the tire sidewall for “LT” type tires

“LT” type tires have some additional information beyond those of “P” type tires; these differences are described below:

1. **LT:** Indicates a tire, designated by the Tire and Rim Association (T&RA), that is intended for service on light trucks.
2. **Load Range/Load Inflation Limits:** Indicates the tire’s load-carrying capabilities and its inflation limits.
3. **Maximum Load Dual lb. (kg) at psi (kPa) cold:** Indicates the maximum load and tire pressure when the tire is used as a dual; defined as four tires on the rear axle (a total of six or more tires on the vehicle).
4. **Maximum Load Single lb. (kg) at psi (kPa) cold:** Indicates the maximum load and tire pressure when the tire is used as a single; defined as two tires (total) on the rear axle.

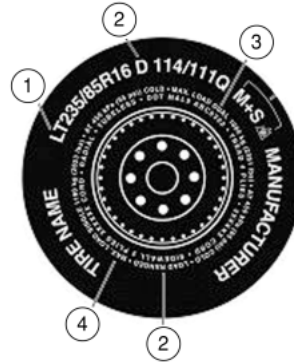

## Tires, Wheels and Loading

### Information on “T” type tires

“T” type tires have some additional information beyond those of “P” type tires; these differences are described below:

T145/80D16 is an example of a tire size.

**Note:** The temporary tire size for your vehicle may be different from this example.

1. **T:** Indicates a type of tire, designated by the Tire and Rim Association (T&RA), that is intended for temporary service on cars, SUVs, minivans and light trucks.
2. **145:** Indicates the nominal width of the tire in millimeters from sidewall edge to sidewall edge. In general, the larger the number, the wider the tire.
3. **80:** Indicates the aspect ratio which gives the tire’s ratio of height to width. Numbers of 70 or lower indicate a short sidewall.
4. **D:** Indicates a “diagonal” type tire.  
**R:** Indicates a “radial” type tire.
5. **16:** Indicates the wheel or rim diameter in inches. If you change your wheel size, you will have to purchase new tires to match the new wheel diameter.

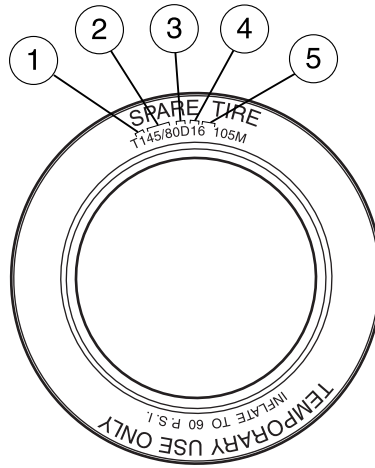

### Location of the Safety Compliance Certification Label

You will find a Safety Compliance Certification Label containing tire inflation pressure by tire size and other important information located on the B-Pillar or the edge of the driver’s door. Refer to the payload description and graphic in the *Vehicle loading — with and without a trailer* section.

## Tires, Wheels and Loading

### TIRE CARE

Improper or inadequate vehicle maintenance can also cause tires to wear abnormally. Here are some of the important maintenance items:

#### Tire wear

Measure and inspect the tire tread on all your tires periodically. Advanced and unusual tire wear can reduce the ability of tread to grip the road in adverse (wet, snowy, etc.) conditions. Visually check your tires for uneven wear, looking for high and low areas or unusually smooth areas. Also check for signs of tire damage.

When the tread is worn down to 1/16th of an inch (2 mm), tires must be replaced to prevent your vehicle from skidding and hydroplaning. Built-in treadwear indicators, or “wear bars”, which look like narrow strips of smooth rubber across the tread will appear on the tire when the tread is worn down to 1/16th of an inch (2 mm). When the tire tread wears down to the same height as these “wear bars”, the tire is worn out and should be replaced.

Inspect your tires frequently for any of the following conditions and replace them if one or more of the following conditions exist:

- Fabric showing through the tire rubber
- Bulges in the tread or sidewalls
- Cracks or cuts on the sidewalls
- Cracks in the tread groove
- Impact damage resulting from use
- Separation in the tread
- Separation in the sidewall
- Severe abrasion on the sidewall

If your vehicle has a leak in the exhaust system, a road tire or the spare tire may be exposed to hot exhaust temperatures requiring the tire to be replaced.

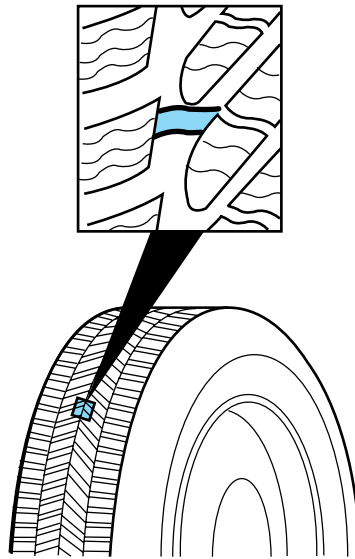

## Tires, Wheels and Loading

### Safety practices

Driving habits have a great deal to do with your tire mileage and safety.

- Observe posted speed limits
- Avoid fast starts, stops and turns
- Avoid potholes and objects on the road
- Do not run over curbs or hit the tire against a curb when parking

**WARNING: If your vehicle is stuck in snow, mud, sand, etc., do not rapidly spin the tires; spinning the tires can tear the tire and cause an explosion. A tire can explode in as little as three to five seconds.**

**WARNING: Never spin the tires in excess of the 35 mph (55 km/h) point indicated on the speedometer.**

### Highway hazards

No matter how carefully you drive there's always the possibility that you may eventually have a flat tire on the highway. Drive slowly to the closest safe area out of traffic. This may further damage the flat tire, but your safety is more important.

If you feel a sudden vibration or ride disturbance while driving, or you suspect your tire or vehicle has been damaged, immediately reduce your speed. Drive with caution until you can safely pull off the road. Stop and inspect the tires for damage. If a tire is under-inflated or damaged, deflate it, remove wheel and replace it with your spare tire and wheel. If you cannot detect a cause, have the vehicle towed to the nearest repair facility or tire dealer to have the vehicle inspected.

### Tire and wheel alignment

A bad jolt from hitting a curb or pothole can cause the front end of your vehicle to become misaligned or cause damage to your tires. If your vehicle seems to pull to one side, vibrate or shake when you're driving, the wheels may be out of alignment. Have a qualified technician at a Mazda dealer check the wheel alignment periodically.

## Tires, Wheels and Loading

Wheel misalignment in the front or the rear can cause uneven and rapid treadwear of your tires and should be corrected by a qualified technician at a Mazda dealer. Front wheel drive (FWD) vehicles and those with an independent rear suspension require alignment of all four wheels.

The tire should also be balanced periodically. An unbalanced tire and wheel assembly may result in irregular tire wear.

**NOTE:** When it is time to replace front tires with new ones, this is an ideal time to perform an alignment. New tires should be balanced at the time they are installed.

### Tire rotation

Rotating your tires at the recommended interval (as indicated in the *Scheduled maintenance* section of the *Maintenance and Specifications* chapter) will help your tires wear more evenly, providing better tire performance and longer tire life.

- Front Wheel Drive (FWD) vehicles (front tires at top of diagram)

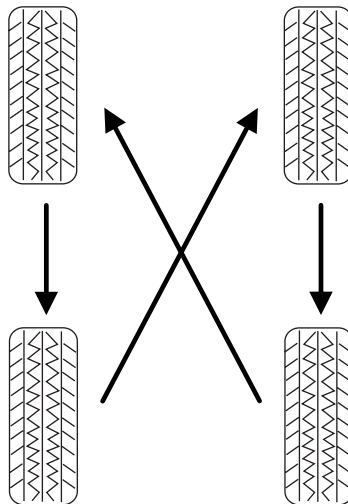

## Tires, Wheels and Loading

- Rear Wheel Drive (RWD) vehicles/Four Wheel Drive (4WD)/All Wheel Drive (AWD) vehicles (front tires at top of diagram)

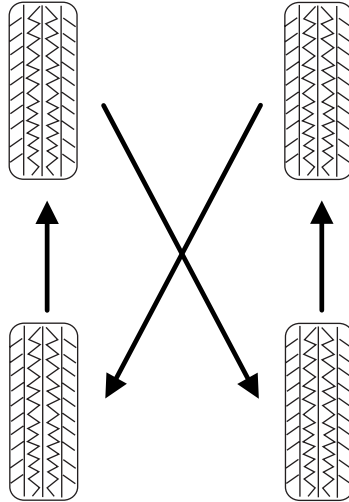

Sometimes irregular tire wear can be corrected by rotating the tires.

**Note:** If your tires show uneven wear ask a qualified technician at a Mazda dealership to check for and correct any wheel misalignment, tire imbalance or mechanical problem involved before tire rotation.

**Note:** Your vehicle may be equipped with a dissimilar spare tire/wheel. A dissimilar spare tire/wheel is defined as a spare tire and/or wheel that is different in brand, size or appearance from the road tires and wheels. If you have a dissimilar spare tire/wheel it is intended for temporary use only and should not be used in a tire rotation.

**Note:** After having your tires rotated, inflation pressure must be checked and adjusted to the vehicle requirements.

### USING SNOW TIRES AND TRACTION DEVICES

**NOTE:** Snow tires must be the same size and grade as the tires you currently have on your vehicle.

The tires on your vehicle have all-weather treads to provide traction in rain and snow. However, in some climates, using snow tires and traction devices may be necessary. If you need to use snow tires and chains, it is recommended that steel wheels are used of the same size and specification as those originally installed.

## Tires, Wheels and Loading

Follow these guidelines when using snow tires and traction devices:

- SAE class “S” cables should ONLY be used on the front axle for P235/70R16 tires.
- Install cables or chains securely, verifying that the chains do not touch any wiring, brake lines or fuel lines.

**Drive cautiously. If you hear the cables or chains rub or bang against the vehicle, stop and retighten them. If this does not work, remove the cables or chains to prevent vehicle damage.**

- Avoid overloading your vehicle.
- Remove the cables or tire chains when they are no longer needed.
- Do not use cables or chains on dry roads.
- The suspension insulation and bumpers will help prevent vehicle damage. Do not remove these components from the vehicle when using snow tires and traction devices.
- Do not exceed 30 mph (48 km/h) with tire chains on your vehicle.

### VEHICLE LOADING – WITH AND WITHOUT A TRAILER

This section will guide you in the proper loading of your vehicle and/or trailer, to keep your loaded vehicle weight within its design rating capability, with or without a trailer. Properly loading your vehicle will provide maximum return of vehicle design performance. Before loading your vehicle, familiarize yourself with the following terms for determining your vehicle’s weight ratings, with or without a trailer, from the vehicle’s Safety Compliance Certification Label:

**Base Curb Weight** – is the weight of the vehicle including a full tank of fuel and all standard equipment. It does not include passengers, cargo, or optional equipment.

**Vehicle Curb Weight** – is the weight of your new vehicle when you picked it up from your dealer plus any aftermarket equipment.

## Tires, Wheels and Loading

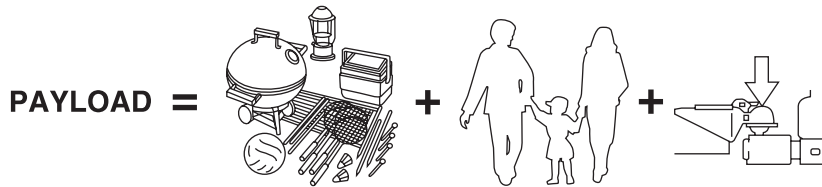

**Payload** – is the combined weight of cargo and passengers that the vehicle is carrying. The maximum payload for your vehicle can be found on the Safety Compliance Certification Label on the B-Pillar or the edge of the driver's door. Look for **“THE COMBINED WEIGHT OF OCCUPANTS AND CARGO SHOULD NEVER EXCEED XXX kg OR XXX lb.”** for maximum payload. The payload listed on the Safety Compliance Certification Label is the maximum payload for the vehicle as built by the assembly plant. If any aftermarket or dealer installed equipment has been installed on the vehicle, the weight of the equipment must be subtracted from the payload listed on the Safety Compliance Certification Label in order to determine the new payload.

**WARNING: The appropriate loading capacity of your vehicle can be limited either by volume capacity (how much space is available) or by payload capacity (how much weight the vehicle should carry). Once you have reached the maximum payload of your vehicle, do not add more cargo, even if there is space available. Overloading or improperly loading your vehicle can contribute to loss of vehicle control and vehicle rollover.**



## Tires, Wheels and Loading

**Example only:**

TIRE AND LOAD INFORMATION			
SEE OWNERS MANUAL FOR ADDITIONAL INFORMATION			
The combined weight of occupants and cargo should never exceed XXX kg or XXX lbs.			
SEATING CAPACITY	TOTAL; 5	FRONT; 2	REAR; 3
ORIGINAL TIRE SIZE		COLD TIRE INFLATION PRESSURE	
FRONT	P195 / 70R14	FRONT	200KPA, 29PSI
REAR	P195 / 70R14	REAR	200KPA, 29PSI
SPARE TIRE SIZE		COLD TIRE INFLATION PRESSURE	
T125/70D15		420KPA, 50PSI	

TIRE AND LOAD INFORMATION			
SEE OWNERS MANUAL FOR ADDITIONAL INFORMATION			
RENSEIGNEMENTS RELATIFS AUX PNEUS ET À LA CHARGE			
CONSULTER LE GUIDE DU PROPRIÉTAIRE POUR DE PLUS AMPLES RENSEIGNEMENTS			
The combined weight of occupants and cargo should never exceed <sup>kg or</sup> XXX kg or XXX lbs.			
La charge du véhicule (occupants et bagages) ne doit jamais dépasser <sup>PM, kg ou</sup> PM, kg ou lbs.			
SEATING CAPACITY	TOTAL	FRONT	REAR
NOMBRE DE PLACES	TOTAL: TS	AVANT: FS	ARRIÈRE: RS
ORIGINAL TIRE SIZE		COLD TIRE INFLATION PRESSURE	
DIMENSIONS DES PNEUS D'ORIGINE		PRESSION DE GONFLAGE À FROID	
FRONT/ AVANT	FTIREXXXXXE	FRONT/ AVANT	FKPA KPA, FPS PSI
REAR/ ARRIÈRE	RTIREXXXXXE	REAR/ ARRIÈRE	RKPA KPA, RPS PSI
SPARE TIRE SIZE		COLD TIRE INFLATION PRESSURE	
DIMENSION DU PNEU SECOURS		PRESSION DE GONFLAGE À FROID	
STIREXXXXXE		SKP KPA, SPS PSI	

**CARGO**

=

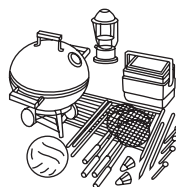

+

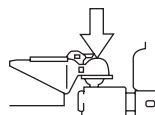

**Cargo Weight** – includes all weight added to the Base Curb Weight, including cargo and optional equipment. When towing, trailer tongue load or king pin weight is also part of cargo weight.

## Tires, Wheels and Loading

**GAW (Gross Axle Weight)** – is the total weight placed on each axle (front and rear) – including vehicle curb weight and all payload.

**GAWR (Gross Axle Weight Rating)** – is the maximum allowable weight that can be carried by a single axle (front or rear). **These numbers are shown on the Safety Compliance Certification Label located on the B-Pillar or the edge of the driver's door. The total load on each axle must never exceed its GAWR.**

**WARNING: Exceeding the Safety Compliance Certification Label axle weight rating limits could result in substandard vehicle handling or performance, engine, transmission and/or structural damage, serious damage to the vehicle, loss of control and personal injury.**

**Note:** For trailer towing information refer to *Trailer towing* found in this chapter or the *RV and Trailer Towing Guide* provided by your dealership.

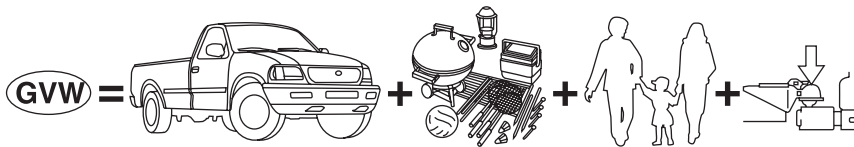

**GVW (Gross Vehicle Weight)** – is the Vehicle Curb Weight + cargo + passengers.

## Tires, Wheels and Loading

**GVWR (Gross Vehicle Weight Rating)** – is the maximum allowable weight of the fully loaded vehicle (including all options, equipment, passengers and cargo). **The GVWR is shown on the Safety Compliance Certification Label located on the B-Pillar or the edge of the driver's door. The GVW must never exceed the GVWR.**

Sample Safety Compliance Certification Label <small>(Refer to actual label on your vehicle)</small>			
Front GAWR	GVWR	Rear GAWR	
<b>MFD. BY FORD MOTOR CO. IN U.S.A.</b>			
DATE: 06/95	GVWR: 6250 LB/2834 KG		
FRONT GAWR: 3450 LB	REAR GAWR: 3777 LB		
1584KG	1713KG		
P265/75R15SL	WITH	P265/75R15SL	WITH
15X7.5J	TIRES	15X7.5J	TIRES
	RIMS		RIMS
AT 30 PSI COLD		AT 30 PSI COLD	
THIS VEHICLE CONFORMS TO ALL APPLICABLE FEDERAL MOTOR VEHICLE SAFETY STANDARDS IN EFFECT ON THE DATE OF MANUFACTURE SHOWN ABOVE.			
XXXXXXXXXXXX			
VIN: 1FTEX14H 0 SKB 00000		F0018	
TYPE: XXXXXXXXXXXXXXXXX		TC183	
			
EXT PNT: XXXXXX XXXXXX			
WD	TYPE:GVW	BODY	TRANS
155	REM	E	HBB
			TAPE
			SPRINGS
			M4

**WARNING: Exceeding the Safety Compliance Certification Label vehicle weight rating limits could result in substandard vehicle handling or performance, engine, transmission and/or structural damage, serious damage to the vehicle, loss of control and personal injury.**



**GCW (Gross Combined Weight)** – is the weight of the loaded vehicle (GVW) plus the weight of the fully loaded trailer.

**GCWR (Gross Combined Weight Rating)** – is the maximum allowable weight of the vehicle and the loaded trailer – including all cargo and passengers – that the vehicle can handle without risking damage.

(Important: The towing vehicle's braking system is rated for operation at GVWR, not at GCWR.) Separate functional brakes should be used for safe control of towed vehicles and for trailers where the GCW of the towing vehicle plus the trailer exceed the GVWR of the towing vehicle.

**The GCW must never exceed the GCWR.**

## Tires, Wheels and Loading

**Maximum Loaded Trailer Weight** – is the highest possible weight of a fully loaded trailer the vehicle can tow. It assumes a vehicle with only mandatory options, no cargo (internal or external), a tongue load of 10–15% (conventional trailer) or king pin weight of 15–25% (fifth wheel trailer), and driver only (150 lb. [68 kg]). **Consult your dealership (or the *RV and Trailer Towing Guide* provided by your dealership) for more detailed information.**

**Tongue Load or Fifth Wheel King Pin Weight** – refers to the amount of the weight that a trailer pushes down on a trailer hitch.

**Examples:** For a 5,000 lb. (2,268 kg) conventional trailer, multiply 5,000 by 0.10 and 0.15 to obtain a proper tongue load range of 500 to 750 lb. (227 to 340 kg). For an 11,500 lb. (5,216 kg) fifth wheel trailer, multiply by 0.15 and 0.25 to obtain a proper king pin load range of 1,725 to 2,875 lb. (782 to 1,304 kg)

**WARNING: Do not exceed the GVWR or the GAWR specified on the Safety Compliance Certification Label.**

**WARNING: Do not use replacement tires with lower load carrying capacities than the originals because they may lower the vehicle's GVWR and GAWR limitations. Replacement tires with a higher limit than the originals do not increase the GVWR and GAWR limitations.**

**WARNING: Exceeding any vehicle weight rating limitation could result in serious damage to the vehicle and/or personal injury.**

### Steps for determining the correct load limit:

1. Locate the statement “The combined weight of occupants and cargo should never exceed XXX kg or XXX lbs.” on your vehicle’s placard.
2. Determine the combined weight of the driver and passengers that will be riding in your vehicle.
3. Subtract the combined weight of the driver and passengers from XXX kg or XXX lbs.
4. The resulting figure equals the available amount of cargo and luggage load capacity. For example, if the “XXX” amount equals 1,400 lbs. and there will be five 150 lb. passengers in your vehicle, the amount of available cargo and luggage load capacity is 650 lbs. (1400–750 (5 x 150) = 650 lb.). In metric units (635–340 (5 x 68) = 295 kg.)

## Tires, Wheels and Loading

5. Determine the combined weight of luggage and cargo being loaded on the vehicle. That weight may not safely exceed the available cargo and luggage load capacity calculated in Step 4.
6. If your vehicle will be towing a trailer, load from your trailer will be transferred to your vehicle. Consult this manual to determine how this reduces the available cargo and luggage load capacity of your vehicle.

The following gives you a few examples on how to calculate the available amount of cargo and luggage load capacity:

- Another example for your vehicle with 1400 lb. (635 kg) of cargo and luggage capacity. You decide to go golfing. Is there enough load capacity to carry you, 4 of your friends and all the golf bags? You and four friends average 220 lb. (99 kg) each and the golf bags weigh approximately 30 lb. (13.5 kg) each. The calculation would be:  $1400 - (5 \times 220) - (5 \times 30) = 1400 - 1100 - 150 = 150$  lb. Yes, you have enough load capacity in your vehicle to transport four friends and your golf bags. In metric units, the calculation would be:  $635 \text{ kg} - (5 \times 99 \text{ kg}) - (5 \times 13.5 \text{ kg}) = 635 - 495 - 67.5 = 72.5$  kg.
- A final example for your vehicle with 1400 lb. (635 kg) of cargo and luggage capacity. You and one of your friends decide to pick up cement from the local home improvement store to finish that patio you have been planning for the past 2 years. Measuring the inside of the vehicle with the rear seat folded down, you have room for 12-100 lb. (45 kg) bags of cement. Do you have enough load capacity to transport the cement to your home? If you and your friend each weigh 220 lb. (99 kg), the calculation would be:  $1400 - (2 \times 220) - (12 \times 100) = 1400 - 440 - 1200 = -240$  lb. No, you do not have enough cargo capacity to carry that much weight. In metric units, the calculation would be:  $635 \text{ kg} - (2 \times 99 \text{ kg}) - (12 \times 45 \text{ kg}) = 635 - 198 - 540 = -103$  kg. You will need to reduce the load weight by at least 240 lb. (104 kg). If you remove 3-100 lb. (45 kg) cement bags, then the load calculation would be:

$1400 - (2 \times 220) - (9 \times 100) = 1400 - 440 - 900 = 60$  lb. Now you have the load capacity to transport the cement and your friend home. .  
In metric units, the calculation would be:  $635 \text{ kg} - (2 \times 99 \text{ kg}) - (9 \times 45 \text{ kg}) = 635 - 198 - 405 = 32$  kg.

The above calculations also assume that the loads are positioned in your vehicle in a manner that does not overload the Front or the Rear Gross Axle Weight Rating specified for your vehicle on the Safety Compliance Certification Label found on the edge of the driver's door.

## Tires, Wheels and Loading

### Special loading instructions for owners of pickup trucks and utility-type vehicles

**WARNING:** For important information regarding safe operation of this type of vehicle, see the *Preparing to drive your vehicle* section in the *Driving* chapter of this *Owner's Guide*.

**WARNING:** Loaded vehicles may handle differently than unloaded vehicles. Extra precautions, such as slower speeds and increased stopping distance, should be taken when driving a heavily loaded vehicle.

Your vehicle can haul more cargo and people than most passenger cars. Depending upon the type and placement of the load, hauling cargo and people may raise the center of gravity of the vehicle.

#### Calculating the load your vehicle can carry/tow

1. Use the appropriate maximum GCWR chart (in the *Trailer towing* section in this chapter) for your type of engine and rear axle ratio.
2. Weigh your vehicle without cargo. To obtain correct weights, take your vehicle to a shipping company or an inspection station for trucks.
3. Subtract your loaded weight from the maximum GCWR in the chart. This is the maximum trailer weight your vehicle can tow. It must be below the maximum trailer weight shown in the chart.

#### TRAILER TOWING

Trailer towing with your vehicle may require the use of a trailer tow option package.

Trailer towing puts additional loads on your vehicle's engine, transaxle, axle, brakes, tires, and suspension. For your safety and to maximize vehicle performance, be sure to use the proper equipment while towing.

Follow these guidelines to ensure safe towing procedure:

- Be sure to locate all the warnings supplied by the trailer rental or sales company and study the unique requirements of each trailer you intend to tow.
- Stay within your vehicle's load limits.
- Thoroughly prepare your vehicle for towing. Refer to *Preparing to tow* in this chapter.

## Tires, Wheels and Loading

- Use extra caution when driving while trailer towing. Refer to *Driving while you tow* in this chapter.
- Service your vehicle more frequently if you tow a trailer. Refer to the “Scheduled Maintenance” section of this manual.
- Do not tow a trailer until your vehicle has been driven at least 500 miles (800 km).
- Refer to the instructions included with towing accessories for the proper installation and adjustment specifications.

Do not exceed the maximum loads listed on the Safety Compliance Certification Label. For load specification terms found on the label, refer to *Vehicle loading* in this chapter. Remember to figure in the tongue load of your loaded vehicle when figuring the total weight.

<b>4x2</b>			
<b>GCWR (Gross Combined Weight Rating)/Trailer Weights</b>			
<b>Engine</b>	<b>Maximum GCWR - lb. (kg)</b>	<b>Trailer Weight Range - lb. (kg)</b>	<b>Maximum frontal area of trailer - ft<sup>2</sup> (m<sup>2</sup>)</b>
2.3L w/manual transmission	4860 (2204)	1500 (680)	24 (2.2)
2.3L w/automatic transmission	4940 (2241)	1500 (680)	24 (2.2)
3.0L w/automatic transmission	7080 (3211)	3500 (1588)	30 (2.8)
<p><b>Notes:</b> For high altitude operation, reduce GCW by 2% per 1,000 ft. (300 meters) elevation. For definitions of terms and instructions on calculating your vehicle’s load, refer to <i>Vehicle Loading</i> in this chapter. Maximum trailer weights shown. The combined weight of the completed towing vehicle and the loaded trailer must not exceed the GCWR.</p>			
<p>The Tribute is capable of pulling the maximum trailer weight(s) as specified above. Certain states require electric trailer brakes for trailers over a specified weight. The Tribute vehicle electrical system is not equipped to accommodate electric trailer brakes.</p>			

## Tires, Wheels and Loading

4x4			
GCWR (Gross Combined Weight Rating)/Trailer Weights			
Engine	Maximum GCWR - lb. (kg)	Trailer Weight Range - lb. (kg)	Maximum frontal area of trailer - ft <sup>2</sup> (m <sup>2</sup> )
2.3L w/manual transmission	5040 (2286)	1500 (680)	24 (2.2)
2.3L w/automatic transmission	5100 (2313)	1500 (680)	24 (2.2)
3.0L w/automatic transmission	7240 (3284)	3500 (1588)	30 (2.8)
<p><b>Notes:</b> For high altitude operation, reduce GCW by 2% per 1,000 ft. (300 meters) elevation. For definitions of terms and instructions on calculating your vehicle's load, refer to <i>Vehicle Loading</i> in this chapter. Maximum trailer weights shown. The combined weight of the completed towing vehicle and the loaded trailer must not exceed the GCWR.</p> <p>The Tribute is capable of pulling the maximum trailer weight(s) as specified above. Certain states require electric trailer brakes for trailers over a specified weight. The Tribute vehicle electrical system is not equipped to accommodate electric trailer brakes.</p>			

**WARNING: Do not exceed the GVWR or the GAWR specified on the certification label.**

Towing trailers beyond the maximum recommended gross trailer weight exceeds the limit of the vehicle and could result in:

- engine damage
- transmission damage
- structural damage
- loss of control
- personal injury



## Tires, Wheels and Loading

### Preparing to tow

Use the proper equipment for towing a trailer and make sure it is properly attached to your vehicle. See your authorized Mazda dealer.

### Hitches

Do not use hitches that clamp onto the vehicle bumper. Use a load carrying hitch. You must distribute the load in your trailer so that 10–15% of the total weight of the trailer is on the tongue.

### Safety chains

Always connect the trailer's safety chains to the frame or hook retainers of the vehicle hitch. To connect the trailer's safety chains, cross the chains under the trailer tongue and allow slack for turning corners.

If you use a rental trailer, follow the instructions that the rental agency gives to you.

**Do not attach safety chains to the bumper.**

### Trailer brakes

Electric, manual, automatic or surge-type brakes, if compatible with the vehicle, are safe if installed properly and adjusted to the manufacturer's specifications. The trailer brakes must meet local and Federal regulations.

**WARNING: Do not connect a trailer's hydraulic brake system directly to your vehicle's brake system. Your vehicle may not have enough braking power and your chances of having a collision greatly increase.**

The braking system of the tow vehicle is rated for operation at the GVWR not GCWR.

### Trailer lamps

Trailer lamps are required on most towed vehicles. Make sure all running lights, brake lights, turn signals and hazard lights are working. Do not connect trailer lamps directly to your vehicle's tail lamps. This can cause damage to your vehicle's electrical system. See your authorized Mazda dealer or trailer rental agency for proper instructions and equipment for hooking up trailer lamps.

## Tires, Wheels and Loading

### Driving while you tow

When towing a trailer:

- Turn off the speed control. The speed control may shut off automatically when you are towing on long, steep grades.
- Consult your local motor vehicle speed regulations for towing a trailer.
- To eliminate excessive shifting, use a lower gear. This will also assist in transmission cooling.
- Anticipate stops and brake gradually.
- Do not exceed the GCWR rating or transmission damage may occur.

### Servicing after towing

If you tow a trailer for long distances, your vehicle will require more frequent service intervals. Refer to the “Scheduled Maintenance” section for more information.

### Trailer towing tips

- Practice turning, stopping and backing up before starting on a trip to get the feel of the vehicle trailer combination. When turning, make wider turns so the trailer wheels will clear curbs and other obstacles.
- Allow more distance for stopping with a trailer attached.
- The trailer tongue weight should be 10–15% of the loaded trailer weight.
- After you have traveled 50 miles (80 km), thoroughly check your hitch, electrical connections and trailer wheel lug nuts.
- To aid in engine/transmission cooling and A/C efficiency during hot weather while stopped in traffic, place the gearshift lever in P (Park) (automatic transmission) or N (Neutral) (manual transmissions).
- Vehicles with trailers should not be parked on a grade. If you must park on a grade, place wheel chocks under the trailer’s wheels.

### Launching or retrieving a boat

When backing down a ramp during boat launching or retrieval,

- Do not allow the static water level to rise above the bottom edge of the rear bumper.
- Do not allow waves to break higher than 6 inches (15 cm) above the bottom edge of the rear bumper.

**Exceeding these limits may allow water to enter critical vehicle components, adversely affecting driveability, emissions, reliability and causing internal transmission damage.**

## Tires, Wheels and Loading

**Replace the rear axle lubricant any time the axle has been submerged in water. Rear axle lubricant quantities are not to be checked or changed unless a leak is suspected or repair required.**

Disconnect the wiring to the trailer before backing the trailer into the water. Reconnect the wiring to the trailer after the trailer is removed from the water. Water entering these areas, while connected, could short-circuit the system.

### RECREATIONAL TOWING

An example of “recreational towing” is towing your vehicle behind a motorhome.

If your vehicle is automatic transaxle equipped, with a 4x2 (front-wheel drive only) configured powertrain, “recreational towing” is permitted by trailering the vehicle with its front wheels on a dolly. This protects the transmission’s internal mechanical components from potential lack of lubrication damage.

If your vehicle is automatic transaxle equipped and 4WD (all-wheel drive), “recreational towing” is permitted only if the vehicle is trailered with all four (4) wheels off the ground. Otherwise, no “recreational towing” is permitted.

If your vehicle is manual transaxle equipped and 2WD or 4WD, shifting the transaxle into neutral permits “flat-towing” (all wheels on the ground) for pulling behind a motorhome. Your vehicle, with well designed towing equipment, may be towed up to a speed of 113 km/h (70 mph) but you should always obey local speed limits.

For other towing requirements, refer to *Wrecker towing* in the *Roadside Emergencies* chapter.

## Driving

### STARTING

#### Positions of the ignition

1. LOCK, locks the gearshift lever and allows key removal.
2. ACCESSORY, allows the electrical accessories such as the radio to operate while the engine is not running.
3. ON, all electrical circuits operational. Warning lights illuminated. Key position when driving.
4. START, cranks the engine. Release the key as soon as the engine starts.

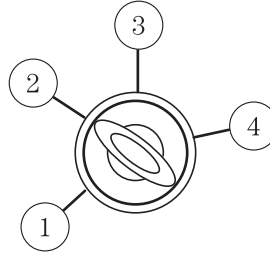

#### Preparing to start your vehicle

Engine starting is controlled by the powertrain control system.

**Note:** This system meets all Canadian Interference-Causing Equipment standard requirements regulating the impulse electrical field strength of radio noise.

When starting a fuel-injected engine, avoid pressing the accelerator before or during starting. Only use the accelerator when you have difficulty starting the engine. For more information on starting the vehicle, refer to *Starting the engine* in this chapter.

**WARNING: Extended idling at high engine speeds can produce very high temperatures in the engine and exhaust system, creating the risk of fire or other damage.**

**WARNING: Do not park, idle, or drive your vehicle in dry grass or other dry ground cover. The emission system heats up the engine compartment and exhaust system, which can start a fire.**

**WARNING: Do not start your vehicle in a closed garage or in other enclosed areas. Exhaust fumes can be toxic. Always open the garage door before you start the engine. See *Guarding against exhaust fumes* in this chapter for more instructions.**

**WARNING: If you smell exhaust fumes inside your vehicle, have your authorized Mazda dealer inspect your vehicle immediately. Do not drive if you smell exhaust fumes.**

### ***Important safety precautions***

A computer system controls the engine's idle revolutions per minute (RPM). When the engine starts, the idle RPM runs higher than normal in order to warm the engine. If the engine idle speed does not slow down automatically, have the vehicle checked by your authorized Mazda dealership.

Before starting the vehicle:

1. Make sure all vehicle occupants have buckled their safety belts. For more information on safety belts and their proper usage, refer to the *Seating and Safety Restraints* chapter.
2. Make sure the headlamps and vehicle accessories are off.

If starting a vehicle with an automatic transmission:

- Make sure the parking brake is set.

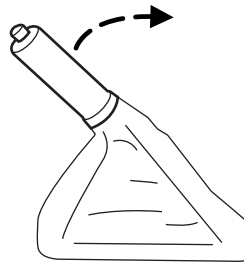

- Make sure the gearshift is in P (Park).

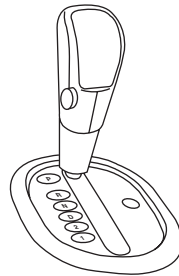

## Driving

If starting a vehicle with a manual transmission:

- Make sure the parking brake is set.
- Push the clutch pedal to the floor.

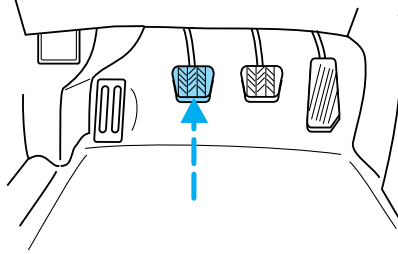

3. Turn the key to 3 (ON) without turning the key to 4 (START).

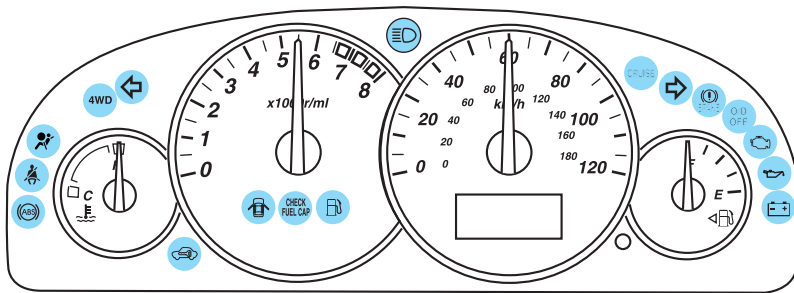
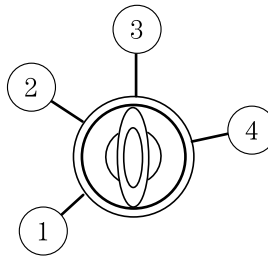

Make sure the corresponding lights illuminate or illuminate briefly. If a light fails to illuminate, have the vehicle serviced.

**Note:** If the driver's safety belt is fastened, the  light may not illuminate.

### Starting the engine

**Note:** Whenever you start your vehicle, release the key as soon as the engine starts. Excessive cranking could damage the starter.

1. Turn the key to 4 (START) without pressing the accelerator pedal and release as soon as the engine starts. The key will return to 3 (ON).
2. When the engine starts, release the key, then release the accelerator pedal gradually as the engine speeds up.
3. After idling for a few seconds, apply the brake, shift into gear and drive.

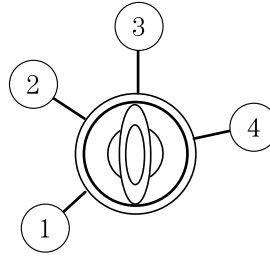

**Note:** If the engine does not start within five seconds on the first try, turn the key to OFF, wait 10 seconds and try again. If the engine still fails to start, press the accelerator to the floor and try again; this will allow the engine to crank with the fuel shut off in case the engine is flooded with fuel.

### Guarding against exhaust fumes

Although odorless and colorless, carbon monoxide is present in exhaust fumes. Take precautions to avoid its dangerous effects.

**WARNING: If you ever smell exhaust fumes of any kind inside your vehicle, have your authorized Mazda dealer inspect and fix your vehicle immediately. Do not drive if you smell exhaust fumes. These fumes are harmful and result in accident or death.**

Have the exhaust and body ventilation systems checked whenever:

- the vehicle is raised for service.
- the sound of the exhaust system changes.
- the vehicle has been damaged in a collision.

## Driving

**WARNING: Engine exhaust, some of its constituents, and certain vehicle components contain or emit chemicals known to the State of California to cause cancer and birth defects or other reproductive harm. In addition, certain fluids contained in vehicles and certain products of component wear contain or emit chemicals known to the State of California to cause cancer and birth defects or other reproductive harm.**

### Important ventilating information

If the engine is idling while the vehicle is stopped in an open area for long periods of time, open the windows at least once inch (2.5 cm).

Adjust the heating or air conditioning (if equipped) to bring in fresh air.

**Note:** Improve vehicle ventilation by keeping all air inlet vents clear of snow, leaves and other debris.

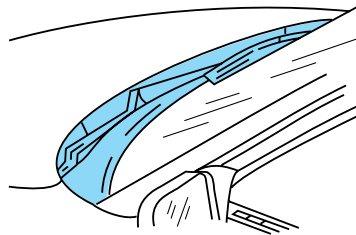

### USING THE ENGINE BLOCK HEATER (IF EQUIPPED)

An engine block heater warms the engine coolant, which improves starting, warms up the engine faster and allows the heater-defroster system to respond quickly. Use of an engine block heater is strongly recommended if you live in a region where temperatures reach  $-10^{\circ}\text{F}$  ( $-23^{\circ}\text{C}$ ) or below.

For best results, plug the heater in at least three hours before starting the vehicle. Using the heater for longer than three hours will not harm the engine, so the heater can be plugged in the night before starting the vehicle.

**WARNING: To reduce the risk of electrical shock, do not use your heater with ungrounded electrical systems or two-pronged (cheater) adapters.**



### BRAKES

Your service brakes are self-adjusting. For service maintenance section about the brakes, refer to the *Scheduled maintenance* section in the *Maintenance and Specification* chapter.

Occasional brake noise is normal and often does not indicate a performance concern with the vehicle's brake system. In normal operation, automotive brake systems may emit occasional or intermittent squeal or groan noises when the brakes are applied. Such noises are usually heard during the first few brake applications in the morning; however, they may be heard at any time while braking and can be aggravated by environmental conditions such as cold, heat, moisture, road dust, salt or mud. If a "metal-to-metal," "continuous grinding" or "continuous squeal" sound is present while braking, the brake linings may be worn-out and should be inspected by an authorized Mazda dealership.

### Four-wheel anti-lock brake system (ABS)

Since your vehicle is equipped with an Anti-lock Braking System (ABS), a noise from the hydraulic pump motor and pulsation in the pedal may be observed during ABS braking events. Pedal pulsation coupled with noise while braking under panic conditions or on loose gravel, bumps, wet or snowy roads is normal and indicates proper functioning of the vehicle's anti-lock brake system.

**NOTE:** The ABS performs a self-check after you start the engine and begin to drive away.

A brief mechanical noise may be heard during this test. This is normal. If a malfunction is found, the ABS warning light will come on. If the vehicle has continuous vibration or shudder in the steering wheel while braking, the vehicle should be inspected by an authorized Mazda dealership.

The ABS operates by detecting the onset of wheel lockup during brake applications and compensates for this tendency. The wheels are prevented from locking even when the brakes are firmly applied. The accompanying illustration depicts the advantage of an ABS equipped vehicle (on bottom) to a non-ABS equipped vehicle (on top) during hard braking with loss of front braking traction.

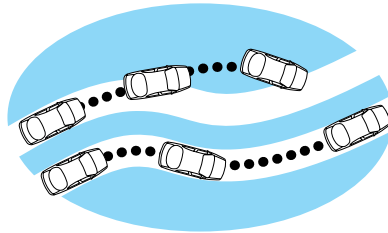

## Driving

**WARNING:** The Anti-Lock system does not decrease the time necessary to apply the brakes or always reduce stopping distance. Always leave enough room between your vehicle and the vehicle in front of you to stop.

### Using four wheel ABS

- In an emergency or when maximum efficiency from the ABS is required, apply continuous force on the brake. The ABS will be activated immediately, thus allowing you to retain steering control of your vehicle and, providing there is sufficient space, will enable you to avoid obstacles and bring the vehicle to a controlled stop.

**NOTE:** We recommend that you familiarize yourself with this braking technique. However, avoid taking any unnecessary risks.

### ABS warning lamp

The  warning lamp in the instrument cluster momentarily illuminates when the ignition is turned on. If the light does not illuminate momentarily at start up, remains on or continues to flash, the ABS needs to be serviced.

With the ABS light on, the anti-lock brake system is disabled and normal braking is still effective unless the brake warning light also remains illuminated with parking brake released. (If your brake warning lamp illuminates, have your vehicle serviced immediately by an authorized Mazda dealership.)

  
**BRAKE**

### Parking brake

Apply the parking brake whenever the vehicle is parked. To set the parking brake, apply the brake pedal and pull the parking brake handle up as far as possible.

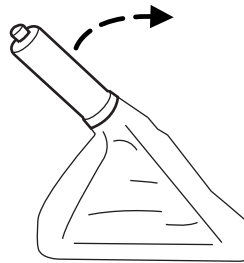

The BRAKE warning lamp in the instrument cluster illuminates and remains illuminated (when the ignition is turned ON) until the parking brake is released.



**WARNING:** Always set the parking brake fully and make sure that the gearshift is securely latched in P (Park) (automatic transmission) or in 1 (First Gear) (manual transmission).

**NOTE:** The parking brake is not recommended to stop a moving vehicle. However, if the normal brakes fail, the parking brake can be used to stop your vehicle in an emergency. Since the parking brake applies only the rear brakes, the vehicle's stopping distance will increase greatly and the handling of your vehicle will be adversely affected.

To release the parking brake, the brake handle may need to be pulled up slightly (1) to release pressure before pushing in the button (2).

**Push the button on the end of the parking brake handle and push the handle down as far as possible. Driving with the parking brake applied will cause the brakes to wear out quickly and reduce fuel economy.**

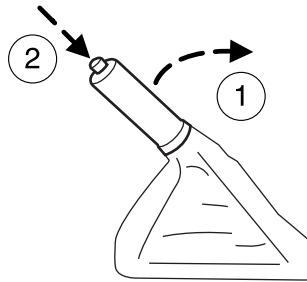

### STEERING

To prevent damage to the power steering system:

- Never hold the steering wheel at its furthest turning points (until it stops) for more than a few seconds when the engine is running
- Do not operate the vehicle with a low power steering pump fluid level (below the MIN mark on the reservoir).
- Some noise is normal during operation. If the noise is excessive, check for low power steering pump fluid level before seeking service by your dealer.
- Heavy or uneven steering efforts may be caused by low power steering pump fluid level. Check for low power steering pump fluid level before seeking service by your dealer.
- Do not fill the power steering pump reservoir above the MAX mark on the reservoir, as this may result in leaks from the reservoir.

## Driving

If the power steering system breaks down (or if the engine is turned off), you can steer the vehicle manually, but it takes more effort. If the steering wanders or pulls, check for:

- an improperly inflated tire
- uneven tire wear
- loose or worn suspension components
- loose or worn steering components
- improper steering alignment

### PREPARING TO DRIVE YOUR VEHICLE

Your vehicle has special design and equipment features to make it capable of performing in a wide variety of circumstances. These special design features, such as larger tires and increased ground clearance, give the vehicle a higher center of gravity than a passenger car.

**WARNING: Utility vehicles have a significantly higher rollover rate than other types of vehicles. Vehicles with a higher center of gravity such as utility and four-wheel drive vehicles handle differently than vehicles with a lower center of gravity. Utility and four-wheel drive vehicles are not designed for cornering at speeds as high as passenger cars any more than low-slung sports cars are designed to perform satisfactorily under off-road conditions. Avoid sharp turns, excessive speed and abrupt maneuvers in these vehicles. Failure to drive cautiously could result in an increased risk of loss of vehicle control, vehicle rollover, personal injury and death.**

**WARNING: In a rollover crash, an unbelted person is significantly more likely to die than a person wearing a seat belt.**

**WARNING: Loaded vehicles, with a higher center of gravity, may handle differently than unloaded vehicles. Extra precautions, such as slower speeds and increased stopping distance, should be taken when driving a heavily loaded vehicle.**

Your vehicle has the capability to haul more cargo and people than most passenger cars. Depending upon the type and placement of the load, hauling people and cargo may raise the center of gravity of the vehicle.

Use extra caution while becoming familiar with your vehicle. Know the capabilities and limitations of both you as a driver and your vehicle.

With a higher center of gravity, the weight and tongue loading warnings and instructions in the towing section are also more important; please consider them carefully. Refer to the *Vehicle Loading* section in this chapter.

### **AUTOMATIC TRANSMISSION OPERATION (IF EQUIPPED)**

#### **Brake-shift interlock**

This vehicle is equipped with a brake-shift interlock feature that prevents the gearshift lever from being moved from P (Park) when the ignition is in the RUN position unless brake pedal is depressed.

If you cannot move the gearshift lever out of P (Park) with ignition in the RUN position and the brake pedal depressed, it is possible that a fuse has blown or the vehicle's brakelamps are not operating properly. Refer to *Fuses and relays* in the *Roadside Emergencies* chapter.

If the fuse is not blown, perform the following procedure:

1. Apply the parking brake, turn the ignition to LOCK, then remove the key.
2. Using a screwdriver or similar tool, carefully pry out the small, round, tethered Brake Transmission Shift Interlock (BTSI) cover cap located to the right of the gearshift lever.

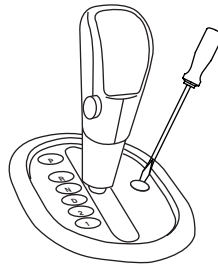

## Driving

3. Insert a screwdriver or similar tool straight down into the access hole and press downward while pulling the gearshift lever out of the P (Park) position and into the N (Neutral) position.

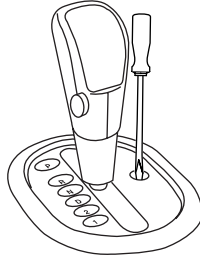

4. Remove tool and reinstall BTSI tethered cover cap.
5. Start the vehicle and release the parking brake.

**WARNING: Do not drive your vehicle until you verify that the brakelamps are working.**

**WARNING: Always set the parking brake fully and make sure the gearshift is latched in P (Park). Turn the ignition to the LOCK position and remove the key whenever you leave your vehicle.**

**WARNING: If the parking brake is fully released, but the brake warning lamp remains illuminated, the brakes may not be working properly. See your authorized Mazda dealership as soon as possible.**

### Driving with an automatic overdrive transaxle

Your automatic overdrive transaxle provides fully automatic operation in either D (Overdrive) or with the O/D OFF switch depressed. Driving with the gearshift lever in D (Overdrive) gives the best fuel economy for normal driving conditions.

For manual control, start in 1 (First) and then shift manually.

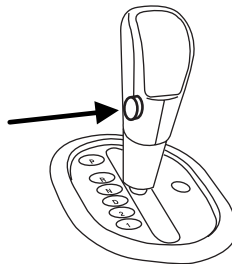

### Understanding the gearshift positions of the 4-speed automatic transaxle

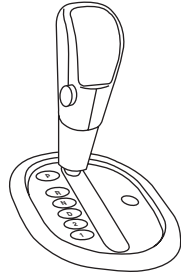

This vehicle is equipped with an adaptive Transmission Shift Strategy. Adaptive Shift Strategy offers the optimal transmission operation and shift quality. When the vehicle's battery has been disconnected for any type of service or repair, the transmission will need to relearn the normal shift strategy parameters, much like having to reset your radio stations when your vehicle battery has been disconnected. The Adaptive Transmission Strategy allows the transmission to relearn these operating parameters. This learning process could take several transmission upshifts and downshifts; during this learning process, slightly firmer shifts may occur. After this learning process, normal shift feel and shift scheduling will resume.

#### **P (Park)**

This position locks the transaxle and prevents the front wheels from turning.

To put your vehicle in gear:

- Start the engine
- Depress the brake pedal
- Move the gearshift lever into the desired gear

To put your vehicle in P (Park):

- Come to a complete stop
- Move the gearshift lever and securely latch it in P (Park)

## Driving

**WARNING:** Always set the parking brake fully and make sure the gearshift is latched in P (Park). Turn the ignition to the LOCK position and remove the key whenever you leave your vehicle.

### R (Reverse)

With the gearshift lever in R (Reverse), the vehicle will move backward. Always come to a complete stop before shifting into and out of R (Reverse).

### N (Neutral)

With the gearshift lever in N (Neutral), the vehicle can be started and is free to roll. Hold the brake pedal down while in this position.

### D (Overdrive)

The normal driving position for the best fuel economy. Transaxle operates in gears one through four. D (Overdrive) can be deactivated by pressing the O/D OFF switch on the side of the gearshift lever. This will illuminate the O/D OFF light and deactivate the overdrive.

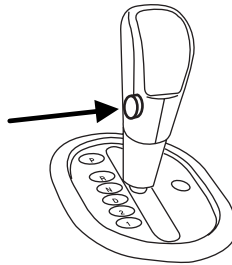

### Drive (O/D OFF switch pressed)

Drive is activated when the O/D OFF switch is pressed.

- This position allows for all forward gears except overdrive.
- O/D OFF light is illuminated.
- Provides engine braking.
- Use when driving conditions cause excessive shifting from O/D to other gears. Examples: city traffic, hilly terrain, heavy loads, trailer towing and when engine braking is required.
- To return to O/D (overdrive mode), press the O/D OFF switch. The O/D OFF light will not be illuminated.
- O/D (Overdrive) is automatically returned each time the key is turned off.



### 2 (Second)

This position allows for second gear only.

- Provides engine braking.
- Use to start-up on slippery roads.
- To return to D (Overdrive), move the gearshift lever into the D (Overdrive) position.
- Selecting 2 (Second) at higher speeds will cause the transaxle to downshift to second gear at the appropriate vehicle speed.

### 1 (First)

- Provides maximum engine braking.
- Allows upshifts by moving gearshift lever.
- Will not downshift into 1 (First) at high speeds; allows for 1 (First) when vehicle reaches slower speeds.

**WARNING: When parking, do not use the gearshift in place of the parking brake. Always set the parking brake fully and make sure that the gearshift is securely latched in P (Park). Turn off the ignition whenever you leave your vehicle. Never leave your vehicle unattended while it is running. If you do not take these precautions, your vehicle may move unexpectedly and injure someone.**

### Forced downshifts

- Allowed in D (Overdrive) or Drive.
- Depress the accelerator to the floor.
- Allows transmission to select an appropriate gear.

### If your vehicle gets stuck in mud or snow

If your vehicle gets stuck in mud or snow, it may be rocked out by shifting between forward and reverse gears, stopping between shifts in a steady pattern. Press lightly on the accelerator in each gear.

**Do not rock the vehicle if the engine is not at normal operating temperature or damage to the transmission may occur.**

**Do not rock the vehicle for more than a minute or damage to the transmission and tires may occur, or the engine may overheat.**

## Driving

### MANUAL TRANSAXLE OPERATION (IF EQUIPPED)

#### Using the clutch

Vehicles equipped with a manual transaxle have a starter interrupt interlock that prevents cranking of the engine unless the clutch pedal is depressed.

When starting a vehicle with a manual transaxle, you must:

1. Put the gearshift lever in the neutral position.

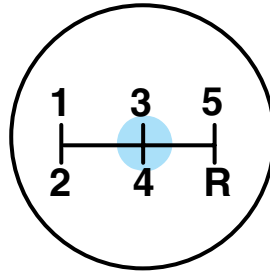

2. Hold down the brake pedal.
3. Depress the clutch pedal to the floor.

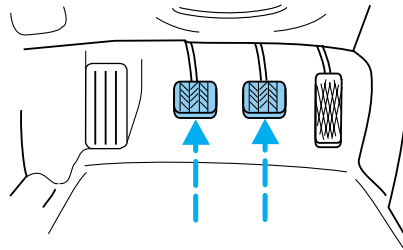

4. Without depressing the accelerator pedal, turn the ignition to position 4 (START), release the ignition as soon as the engine starts.
5. Let the engine idle for a few seconds.
6. Release the brake pedal, then slowly release the clutch pedal while pressing down slowly on the accelerator pedal.

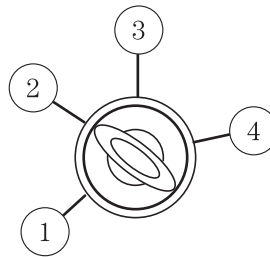

## Driving

**Do not drive with your foot resting on the clutch pedal and do not use the clutch pedal to hold your vehicle at a standstill while waiting on a hill. These actions will seriously reduce clutch life.**

### Recommended shift speeds

Upshift according to the following charts for best fuel economy:

Upshifts when accelerating (recommended for best fuel economy)	
1-2	14 mph (22 km/h)
2-3	25 mph (40 km/h)
3-4	34 mph (55 km/h)
4-5	44 mph (70 km/h)

  

Upshifts when cruising (recommended for best fuel economy)	
1-2	12 mph (19 km/h)
2-3	19 mph (31 km/h)
3-4	29 mph (46 km/h)
4-5	38 mph (61 km/h)

### Reverse

**Make sure that your vehicle is at a complete stop before you shift into R (Reverse). Failure to do so may damage the transaxle.**

Put the gearshift lever into the neutral position and wait at least three seconds before shifting into R (Reverse).

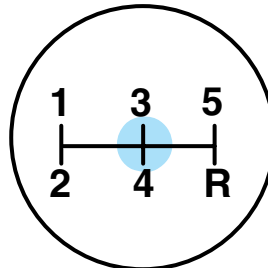

**Note:** You can shift into R (Reverse) only by moving the gearshift lever from left of 3 (Third) and 4 (Fourth) gears before you shift into R (Reverse). This is a special lockout feature which prevents you from shifting into R (Reverse) when you downshift from 5 (Fifth).

## Driving

### Parking your vehicle

1. Apply the brake and shift into the neutral position.

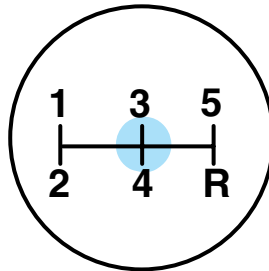

2. Set the parking brake.

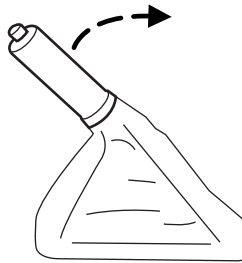

3. Depress the clutch, then shift into 1 (First).

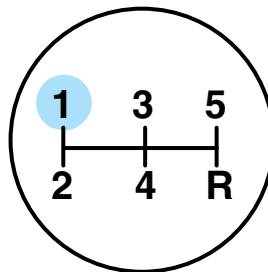

## Driving

4. Turn the ignition to position 1 (LOCK) to shut the engine off and remove the ignition key.

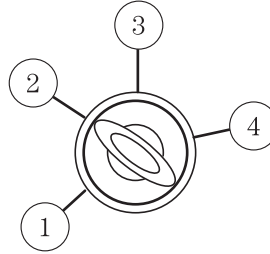

**WARNING: Do not park your vehicle in Neutral, it may move unexpectedly and injure someone. Use 1 (First) gear and set the parking brake fully.**

### FOUR WHEEL DRIVE (4WD) SYSTEM (IF EQUIPPED)

**WARNING: For important information regarding safe operation of this type of vehicle, see *Preparing to drive your vehicle* in this chapter.**

Your vehicle is equipped with an intelligent 4WD System that continuously monitors vehicle conditions and automatically adjusts the power distribution between the front and rear wheels. It combines transparent all-surface operation with highly capable four-wheel drive.

The 4WD system is always active and requires no driver input. It is capable of handling all road conditions, including street and highway driving as well as off-road and winter driving.

During very extreme off-road events, the 4WD system has a heat protection mode to protect itself from damage. If the system detects an overheat condition, it will enter a locked mode. If the heat in the 4WD system continues to rise in locked mode, it will disable itself. To exit heat protection mode, simply stop the vehicle and allow it to cool for five minutes with the key in the 3 (RUN) position.

#### 4WD system indicator lights

- **Blinks continuously** when 4WD system is disengaged (i.e. two wheel drive) due to heat protection mode.

**4WD**

## Driving

- **Blinks several times every minute** when 4WD system requires service. Please bring your vehicle to your local dealer for service.

### **Driving off-road with truck and utility vehicles**

4WD vehicles are specially equipped for driving on sand, snow, mud and rough terrain and have operating characteristics that are somewhat different from conventional vehicles, both on and off the road.

#### ***How your vehicle differs from other vehicles***

Truck and utility vehicles can differ from some other vehicles. Your vehicle may be higher to allow it to travel over rough terrain without getting hung up or damaging underbody components.

The differences that make your vehicle so versatile also make it handle differently than an ordinary passenger car.

**Maintain steering wheel control at all times, especially in rough terrain. Since sudden changes in terrain can result in abrupt steering wheel motion, make sure you grip the steering wheel from the outside. Do not grip the spokes.**

**Drive cautiously to avoid vehicle damage from concealed objects such as rocks and stumps.**

You should either know the terrain or examine maps of the area before driving. Map out your route before driving in the area. To maintain steering and braking control of your vehicle, you must have all four wheels on the ground and they must be rolling, not sliding or spinning.

#### ***Basic operating principles***

- Drive slower in strong crosswinds which can affect the normal steering characteristics of your vehicle.
- Be extremely careful when driving on pavement made slippery by loose sand, water, gravel, snow or ice.

#### ***If your vehicle goes off the edge of the pavement***

- If your vehicle goes off the edge of the pavement, slow down, but avoid severe brake application, ease the vehicle back onto the pavement only after reducing your speed. Do not turn the steering wheel too sharply while returning to the road surface.
- It may be safer to stay on the apron or shoulder of the road and slow down gradually before returning to the pavement. You may lose control if you do not slow down or if you turn the steering wheel too sharply or abruptly.

## Driving

- It often may be less risky to strike small objects, such as highway reflectors, with minor damage to your vehicle rather than attempt a sudden return to the pavement which could cause the vehicle to slide sideways out of control or rollover. Remember, your safety and the safety of others should be your primary concern.

**WARNING: Vehicles with a higher center of gravity such as utility and four-wheel drive vehicles handle differently than vehicles with a lower center of gravity. Utility and four-wheel drive vehicles are not designed for cornering at speeds as high as passenger cars any more than low-slung sports cars are designed to perform satisfactorily under off-road conditions. Avoid sharp turns, excessive speed and abrupt maneuvers in these vehicles. Failure to drive cautiously could result in an increased risk of loss of vehicle control, vehicle rollover, personal injury and death.**

### ***If your vehicle gets stuck***

If your vehicle gets stuck in mud or snow it may be rocked out by shifting between forward and reverse gears, stopping between shifts, in a steady pattern. Press lightly on the accelerator in each gear.

**Do not rock the vehicle if the engine is not at normal operating temperature or damage to the transmission may occur.**

**Do not rock the vehicle for more than a few minutes or damage to the transmission and tires may occur or the engine may overheat.**

**WARNING: Always set the parking brake fully and make sure the gearshift is latched in 1st gear or R (Reverse) (manual transaxles) or P (Park) (automatic transaxles). Turn the ignition to the LOCK position and remove the key whenever you leave your vehicle.**

**WARNING: If the parking brake is fully released, but the brake warning lamp remains illuminated, the brakes may not be working properly. See your authorized Mazda dealership.**

**Do not rock the vehicle if the engine is not at normal operating temperature or damage to the transaxle may occur.**

## Driving

**WARNING: Do not spin the wheels at over 35 mph (56 km/h). The tires may fail and injure a passenger or bystander.**

### **Emergency maneuvers**

- In an unavoidable emergency situation where a sudden sharp turn must be made, remember to avoid “over-driving” your vehicle, i.e., turn the steering wheel only as rapidly and as far as required to avoid the emergency. Excessive steering will result in less vehicle control, not more. Additionally, smooth variations of the accelerator and/or brake pedal pressure should be utilized if changes in vehicle speed are called for. Avoid abrupt steering, acceleration or braking which could result in an increased risk of loss of vehicle control, vehicle rollover and/or personal injury. Use all available road surface to return the vehicle to a safe direction of travel.
- In the event of an emergency stop, avoid skidding the tires and do not attempt any sharp steering wheel movements.

**WARNING: Vehicles with a higher center of gravity such as utility and four-wheel drive vehicles handle differently than vehicles with a lower center of gravity. Utility and four-wheel drive vehicles are not designed for cornering at speeds as high as passenger cars any more than low-slung sports cars are designed to perform satisfactorily under off-road conditions. Avoid sharp turns, excessive speed and abrupt maneuvers in these vehicles. Failure to drive cautiously could result in an increased risk of loss of vehicle control, vehicle rollover, personal injury and death.**

- If the vehicle goes from one type of surface to another (i.e., from concrete to gravel) there will be a change in the way the vehicle responds to a maneuver (steering, acceleration or braking). Again, avoid these abrupt inputs.

### **Sand**

When driving over sand, try to keep all four wheels on the most solid area of the trail. Avoid reducing the tire pressures but shift to a lower gear and drive steadily through the terrain. Apply the accelerator slowly and avoid spinning the wheels.



## Driving

Avoid excessive speed because vehicle momentum can work against you and cause the vehicle to become stuck to the point that assistance may be required from another vehicle. Remember, you may be able to back out the way you came if you proceed with caution.

### **Mud and water**

#### **NOTE:**

- If you must drive through high water, drive slowly. Traction or brake capability may be limited.
- When driving through water, determine the depth; avoid water higher than the bottom of the hubs (if possible) and proceed slowly. If the ignition system gets wet, the vehicle may stall.
- Once through water, always try the brakes. Wet brakes do not stop the vehicle as effectively as dry brakes. Drying can be improved by moving your vehicle slowly while applying light pressure on the brake pedal.

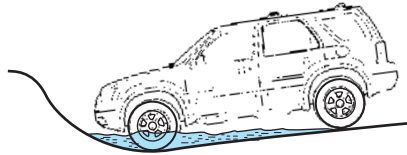

Be cautious of sudden changes in vehicle speed or direction when you are driving in mud. Even 4WD vehicles can lose traction in slick mud. As when you are driving over sand, apply the accelerator slowly and avoid spinning your wheels. If the vehicle does slide, steer in the direction of the slide until you regain control of the vehicle.

**After driving through mud, clean off residue stuck to rotating driveshafts, halfshafts and tires. Excess mud on tires and rotating driveshafts causes an imbalance that could damage drive components.**

#### **NOTE:**

If the transaxle Power Take Off unit or rear axle are submerged in water, their fluids should be checked and changed, if necessary.

**Driving through deep water may damage the transmission.**

If the rear axle is submerged in water, the axle lubricant should be checked and changed, if necessary. The rear axle is filled with a lubricant that does not normally require a lubricant change for the life of the vehicle. Rear axle lubricant quantities should not need to be checked unless a leak is suspected.

## Driving

“Tread Lightly” is an educational program designed to increase public awareness of land-use regulations and responsibilities in our nations wilderness areas. Mazda Motor



Corporation joins the U.S. Forest Service and the Bureau of Land Management in encouraging you to help preserve our national forest and other public and private lands by “treading lightly.”

### ***Driving on hilly or sloping terrain***

Although natural obstacles may make it necessary to travel diagonally up or down a hill or steep incline, you should always try to drive straight up or straight down. **Avoid driving crosswise or turning on steep slopes or hills.** A danger lies in losing traction, slipping sideways and possibly rolling over. Whenever driving on a hill, determine beforehand the route you will use. Do not drive over the crest of a hill without seeing what conditions are on the other side. Do not drive in reverse over a hill without the aid of an observer.

When climbing a steep slope or hill, start in a lower gear rather than downshifting to a lower gear from a higher gear once the ascent has started. This reduces strain on the engine and the possibility of stalling.

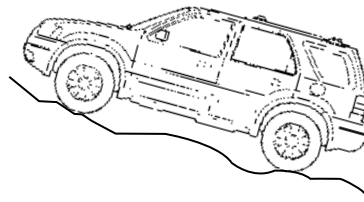

If you do stall out, Do not try to turnaround because you might roll over. It is better to back down to a safe location.

Apply just enough power to the wheels to climb the hill. Too much power will cause the tires to slip, spin or lose traction, resulting in loss of vehicle control.

## Driving

Descend a hill in the same gear you would use to climb up the hill to avoid excessive brake application and brake overheating. Do not descend in neutral; instead, disengage overdrive or manually shift to a lower gear. When descending a steep hill, avoid sudden hard braking as you could lose control. When you brake hard, the front wheels can't turn and if they aren't turning, you won't be able to steer. The front wheels have to be turning in order to steer the vehicle. Rapid pumping of the brake pedal will help you slow the vehicle and still maintain steering control.

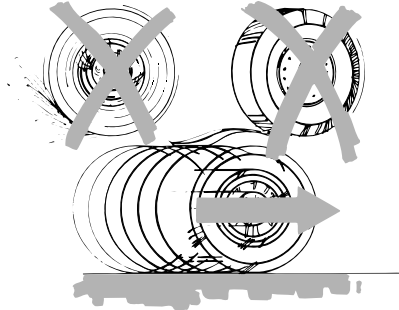

If your vehicle has anti-lock brakes, apply the brakes steadily. Do not “pump” the brakes.

### **Driving on snow and ice**

- 4WD vehicles have advantages over 2WD vehicles in snow and ice but can skid like any other vehicle.
- Should you start to slide while driving on snowy or icy roads, turn the steering wheel in the direction of the slide until you regain control.
- Avoid sudden applications of power and quick changes of direction on snow and ice. Apply the accelerator slowly and steadily when starting from a full stop.
- Avoid sudden braking as well. Although a 4WD vehicle may accelerate better than a two-wheel drive vehicle in snow and ice, it won't stop any faster, because as in other vehicles, braking occurs at all four wheels. Do not become overconfident as to road conditions.
- Make sure you allow sufficient distance between you and other vehicles for stopping. Drive slower than usual and consider using one of the lower gears. In emergency stopping situations, avoid locking of the wheels. Use a “squeeze” technique, push on the brake pedal with a steadily increasing force which allows the wheels to brake yet continue to roll so that you may steer in the direction you want to travel. If you lock the wheels, release the brake pedal and repeat the squeeze technique. Since your vehicle is equipped with a Four Wheel Anti-Lock Brake System (ABS), apply the brake steadily. Do not “pump” the brakes. Refer to the *Brakes* section of this chapter for additional information on the operation of the anti-lock brake system.

## Driving

- 4WD vehicles should be driven with traction devices as referred to in *Using snow tires and traction devices* in the *Tires, Wheels and Loading* chapter.

### **Maintenance and Modifications**

The suspension and steering systems on your vehicle have been designed and tested to provide predictable performance whether loaded or empty and durable load carrying capability. For this reason, Mazda Motor Corporation strongly recommends that you do not make modifications such as adding or removing parts (such as lift kits or stabilizer bars) or by using replacement parts not equivalent to the original factory equipment.

Any modifications to a vehicle that raise the center of gravity can make it more likely the vehicle will roll over as a result of a loss of control. Mazda Motor Corporation recommends that caution be used with any vehicle equipped with a high load or device (such as ladder racks or pickup box cover).

Failure to maintain your vehicle properly may void the warranty, increase your repair cost, reduce vehicle performance and operational capabilities and adversely affect driver and passenger safety. Frequent inspection of vehicle chassis components is recommended if the vehicle is subjected to heavy off-road usage.

### **DRIVING THROUGH WATER**

**Do not drive quickly through standing water, especially if the depth is unknown. Traction or brake capability may be limited and if the ignition system gets wet, your engine may stall. Water may also enter your engine's air intake and severely damage your engine.**

If driving through deep or standing water is unavoidable, proceed very slowly. Never drive through water that is higher than the bottom of the hubs (for trucks) or the bottom of the wheel rims (for cars).

Once through the water, always dry the brakes. Wet brakes do not stop the vehicle as effectively as dry brakes. Drying can be improved by moving your vehicle slowly while applying light pressure on the brake pedal.

**Driving through deep water where the transmission vent tube is submerged may allow water into the transmission and cause internal transmission damage. Have the fluid checked and, if water is found, replace the fluid.**

## Roadside Emergencies

### HAZARD FLASHER CONTROL

The hazard flasher is located on the instrument panel by the radio. The hazard flashers will operate when the ignition is in any position or if the key is not in the ignition.



Push in the flasher control and all front and rear direction signals will flash. Press the flasher control again to turn them off. Use it when your vehicle is disabled and is creating a safety hazard for other motorists.

**Note:** With extended use, the flasher may run down your battery.

### FUEL PUMP SHUT-OFF SWITCH

This device stops the electric fuel pump from sending fuel to the engine when your vehicle has had a substantial jolt.

After an accident, if the engine cranks but does not start, this switch may have been activated.

This switch is located in the front passenger's footwell, by the kick panel access cover.

To reset the switch:

1. Turn the ignition OFF.
2. Check the fuel system for leaks.
3. Remove the kick panel access cover, located in the front passenger's footwell.
4. If no leaks are apparent, reset the switch by pushing in on the reset button.
5. Turn the ignition ON.
6. Wait a few seconds and return the key to OFF.
7. Make another check for leaks.

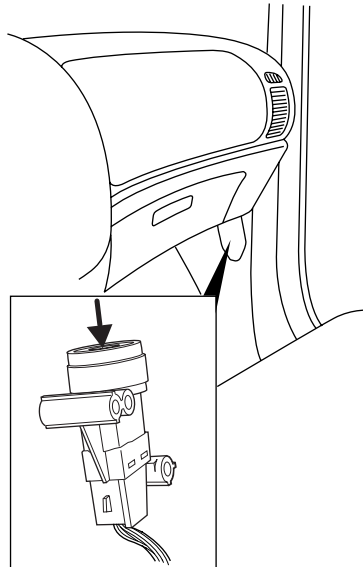

## Roadside Emergencies

### FUSES AND RELAYS

#### Fuses

If electrical components in the vehicle are not working, a fuse may have blown. Blown fuses are identified by a broken wire within the fuse. Check the appropriate fuses before replacing any electrical components.

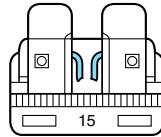

**Note:** Always replace a fuse with one that has the specified amperage rating. Using a fuse with a higher amperage rating can cause severe wire damage and could start a fire.

#### Standard fuse amperage rating and color

COLOR					
Fuse rating	Mini fuses	Standard fuses	Maxi fuses	Cartridge maxi fuses	Fuse link cartridge
2A	Grey	Grey	—	—	—
3A	Violet	Violet	—	—	—
4A	Pink	Pink	—	—	—
5A	Tan	Tan	—	—	—
7.5A	Brown	Brown	—	—	—
10A	Red	Red	—	—	—
15A	Blue	Blue	—	—	—
20A	Yellow	Yellow	Yellow	Blue	Blue
25A	Natural	Natural	—	—	—
30A	Green	Green	Green	Pink	Pink
40A	—	—	Orange	Green	Green
50A	—	—	Red	Red	Red
60A	—	—	Blue	—	Yellow
70A	—	—	Tan	—	Brown
80A	—	—	Natural	—	Black

## Roadside Emergencies

### Passenger compartment fuse panel

The fuse panel is located on the right-hand side of the center console, by the instrument panel. Remove the panel cover to access the fuses.

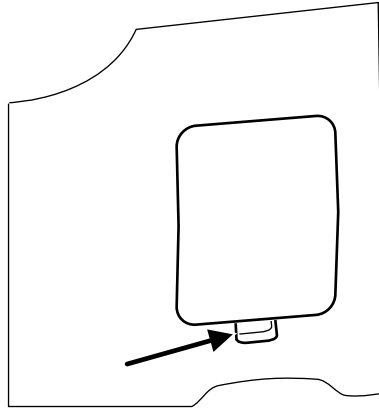

To remove a fuse use the fuse puller tool provided on the fuse panel cover.

## Roadside Emergencies

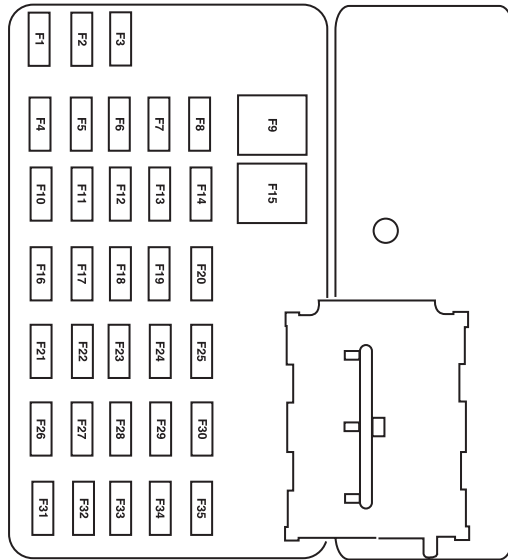

The fuses are coded as follows:

Fuse/Relay Location	Fuse Amp Rating	Passenger Compartment Fuse Panel Description
1	15A*	Trailer tow park lamps
2	5A*	Radio (illumination)
3	15A*	Front and rear park lamps
4	10A*	Ignition switch
5	2A*	Powertrain Control Module (PCM relay), Fuel pump relay, Main fan relay, High/Low speed fan relay 2, PATS module
6	15A*	Center High-Mounted Stop Lamp (CHMSL), Stop lamps, PCM, Anti-lock Brake System (ABS), Speed control, Brake On-Off switch



## Roadside Emergencies

Fuse/Relay Location	Fuse Amp Rating	Passenger Compartment Fuse Panel Description
7	10A*	Instrument cluster, Diagnostic connector, Power mirror switch, Radio
8	—	Not used
9	30A**	Power door locks, Power seats
10	15A*	Heated mirrors
11	15A*	Sunroof
12	—	Not used
13	—	Not used
14	—	Not used
15	30A**	Power windows
16	15A*	Subwoofer
17	15A*	Low beams
18	10A*	4WD
19	—	Not used
20	15A*	Horn
21	10A*	Rear wiper motor, Rear wiper washer
22	10A*	Instrument cluster
23	5A*	Radio (power)
24	20A*	Cigar lighter
25	20A*	Front wiper motor, Front wiper washer
26	5A*	Climate control system mode switch
27	5A*	Canister vent, Speed control cancel switch
28	10A*	Instrument cluster
29	—	Not used
30	—	Not used
31	—	Not used
32	10A*	Brake-Transmission shift lock

## Roadside Emergencies

Fuse/Relay Location	Fuse Amp Rating	Passenger Compartment Fuse Panel Description
33	15A*	Air bag module, Passenger Air bag Deactivation (PAD) indicator lamp, Occupant Classification Sensor (OCS)
34	5A*	ABS module, Evac and Fill, Speed control
35	5A*	Heated seats module, 4WD

\* Mini fuse \*\* Cartridge fuse

### Power distribution box

The power distribution box is located in the engine compartment. The power distribution box contains high-current fuses that protect your vehicle's main electrical systems from overloads.

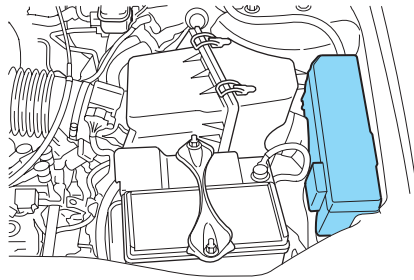

**WARNING: Always disconnect the battery before servicing high current fuses.**

**WARNING: To reduce risk of electrical shock, always replace the cover to the Power Distribution Box before reconnecting the battery or refilling fluid reservoirs.**

If the battery has been disconnected and reconnected, refer to the *Battery* section of the *Maintenance and Specifications* chapter.

## Roadside Emergencies

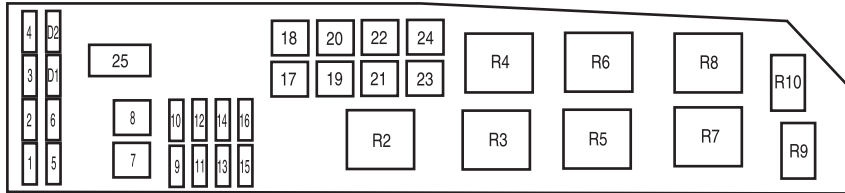

The high-current fuses are coded as follows.

Fuse/Relay Location	Fuse Amp Rating	Power Distribution Box Description
1	—	Not used
2	25A*	Headlamp power
3	25A*	High beams, Turn signals, Interior lamps, Headlamp power
4	5A*	Keep Alive Power (KA PWR)
5	15A*	Heated Exhaust Gas Oxygen (HEGO) sensors
6	20A*	Fuel pump
7	40A**	RUN/ACC relay - Cigar lighter, Front and rear wipers
8	30A**	Powertrain Control Module (PCM), Injectors and coil
9	15A*	Alternator
10	30A*	Heated seats
11	10A*	PCM
12	20A*	Power point
13	20A*	Fog lamps
14	15A*	A/C clutch, A/C relay
15	30A*	Anti-lock Brake System (ABS) solenoid
16	25A*	I/P fuse panel (RUN/START)
17	50A**	Ignition (main)
18	40A**	Blower motor

## Roadside Emergencies

Fuse/Relay Location	Fuse Amp Rating	Power Distribution Box Description
19	40A**	Accessory delay relay - Subwoofer and 4WD, Low beam
20	60A**	ABS
21	40A**	Horn, CHMSL, Cluster, Power locks and power seats
22	40A** (I4)	Cooling fan
	50A** (V6)	
23	40A**	Rear defroster, Park lamps relay
24	40A** (I4)	High/Low speed fan
	50A** (V6)	
25	—	Shunt
R2	—	PCM relay
R3	—	Fuel pump relay
R4	—	Cooling fan relay
R5	—	High/Low speed fan relay 1
R6	—	Blower motor relay
R7	—	Starter relay
R8	—	High/Low speed fan relay 2
R9	—	Fog lamps relay
R10	—	A/C relay
D1	—	Not used
D2	—	A/C diode

\* Mini fuse \*\* Cartridge fuse

### CHANGING A FLAT TIRE

If you get a flat tire while driving:

- do not brake heavily.
- gradually decrease the vehicle's speed.
- hold the steering wheel firmly.
- slowly move to a safe place on the side of the road.

**WARNING: The use of tire sealants may damage your tires.**

## Roadside Emergencies

### **T-Type/Mini-Spare Tire Information (if equipped)**

Your vehicle may be equipped with a T-type/mini-spare tire. This tire will have the words "Temporary Use Only" molded into the tire sidewall. This spare tire is considered "temporary". Replace the T-type/mini-spare with a tire of the same size, speed rating and load carrying capacity as the other road tires as soon as possible.

When driving with the T-type/mini-spare tire **do not:**

- Exceed 50 mph (80 km/h)
- Load the vehicle beyond maximum vehicle load rating listed on the Safety Compliance Label
- Tow a trailer
- Use snow chains on the end of the vehicle with the T-type/mini spare tire
- Use more than one T-type/mini spare tire at a time
- Use commercial car washing equipment
- Try to repair the T-type/mini spare tire

Use of a T-type/mini spare tire at any one wheel location can lead to impairment of the following:

- Handling, stability and braking performance
- Comfort and noise
- Ground clearance and parking at curbs
- Winter weather driving capability
- Wet weather driving capability

### ***Dissimilar spare tire/wheel information (if equipped)***

**WARNING: Failure to follow these guidelines could result in an increased risk of loss of vehicle control, injury or death.**

Your vehicle may be equipped with a dissimilar spare tire/wheel. A dissimilar spare tire/wheel is defined as a spare tire and/or wheel that is different in brand, size or appearance from the road tires and wheels. If you have a dissimilar spare tire/wheel, then it is intended for temporary use only. This means that if you need to use it, you should replace it as soon as possible with a road tire/wheel that is the same size and type as the road tires and wheels that were originally provided by Mazda. If the dissimilar spare tire or wheel is damaged, it should be replaced rather than repaired.

## Roadside Emergencies

When driving with the dissimilar spare tire/wheel, **do not:**

- Exceed 70 mph (113 km/h)
- Use more than one dissimilar spare tire/wheel at a time
- Use commercial car washing equipment
- Use snow chains on the end of the vehicle with the dissimilar spare tire/wheel

The usage of a dissimilar spare tire/wheel can lead to impairment of the following:

- Handling, stability and braking performance
- Comfort and noise
- Ground clearance and parking at curbs
- Winter weather driving capability
- Wet weather driving capability
- All-Wheel driving capability (if applicable)
- Load leveling adjustment (if applicable)

When driving with the dissimilar spare tire/wheel additional caution should be given to:

- Towing a trailer
- Driving vehicles equipped with a camper body
- Driving vehicles with a load on the cargo rack

Drive cautiously when using a dissimilar spare tire/wheel and seek service as soon as possible.

### Tire change procedure

**WARNING: When one of the front wheels is off the ground, the transmission alone will not prevent the vehicle from moving or slipping off the jack, even if the vehicle is in P (Park) (automatic transaxle) or R (Reverse) (manual transaxle).**

**WARNING: To prevent the vehicle from moving when you change a tire, be sure the parking brake is set, then block both sides of the wheel that is diagonally opposite (other side and end of the vehicle) to the tire being changed.**

## Roadside Emergencies

**WARNING:** Changing a tire is dangerous if not done properly. The vehicle can slip off the jack and seriously injure you or someone. Be sure to follow the directions for changing a tire, and never get under a vehicle that is supported only by a jack.

**WARNING:** If the vehicle slips off the jack, you or someone else could be seriously injured.

1. Park on a level surface, activate hazard flashers and place gearshift lever in P (Park) (automatic transmission) or R (Reverse) (manual transmission).
2. Set the parking brake and turn engine off.
3. Block the diagonally opposite wheel.

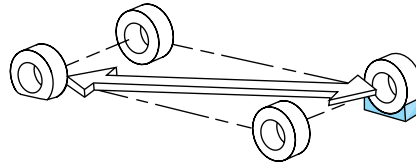
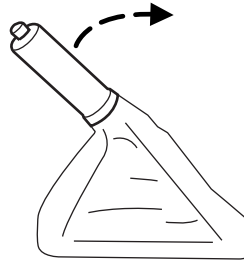

### **Removing the jack and tools**

**Non-cargo management system (if equipped):** The jack and tools are located under the carpeted hardboard.

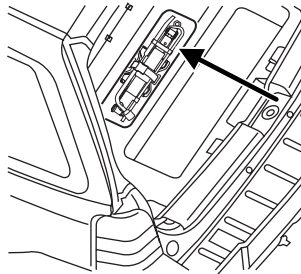

## Roadside Emergencies

Pull back the carpet away from the lift gate, and remove the hardboard cover.

Unbuckle the strap and remove the jack and tools by pulling the right side up first. Remove the tools from the jack in order to remove the spare tire from under the vehicle.

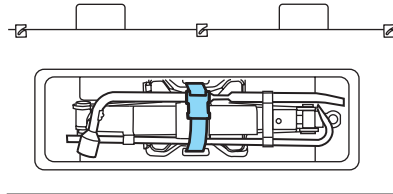

**Note:** For some non-cargo management system vehicles, the jack and tools are located in the right rear of the cargo area behind an access panel.

**Cargo management system (if equipped):** The jack and tools are located in the right rear of the cargo area behind an access panel.

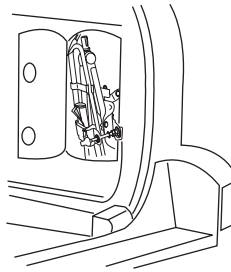



## Roadside Emergencies

To remove jack from vehicle:

1. Release the thumbscrew on the bracket.
2. Release the retention clip on the upper part of the jack bracket.
3. Dislodge the jack from the bracket and carefully guide jack down and out through trim opening, upper end out first.

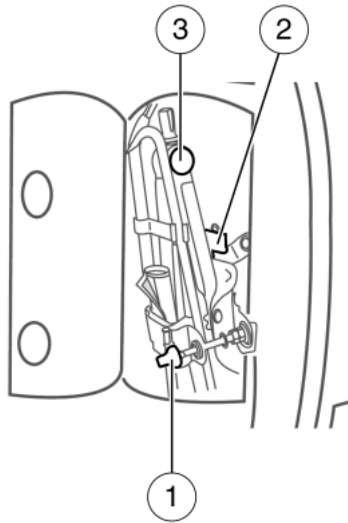

Remove the lug wrench from the jack in order to remove the spare tire from under the vehicle.

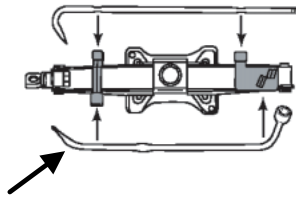

### **Removing the spare tire or spare tire and tether (if equipped)**

1. Insert the lug wrench through the access hole in the rear bumper.
2. Turn the handle counterclockwise and lower the spare tire until it can be slid rearward and the cable is slack.
3. Slide the retainer through the center of the wheel.

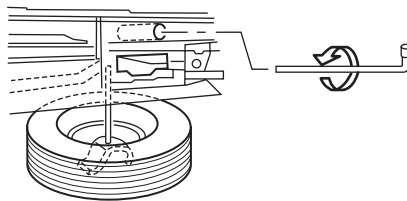

## Roadside Emergencies

If equipped with a tether, perform the following additional steps:

4. Lift the spare tire on end to access tether attachment (1).

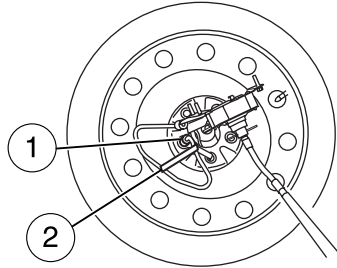

5. Use the lug wrench to remove the lug nut from the spare tire tether.

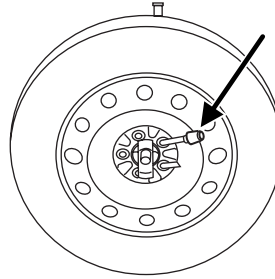

6. If not replacing the spare or flat tire to the underbody storage area, raise winch up into the installed position.

7. Use the attached Velcro strap (2) to tie the tether end to the winch actuator shaft (if equipped).

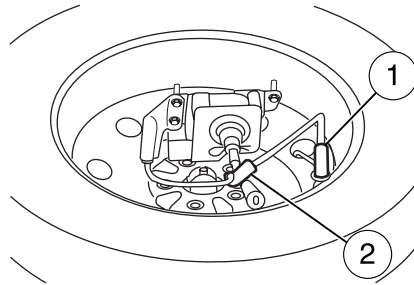

## Roadside Emergencies

### Changing the flat tire

- Loosen each wheel lug nut one-half turn counterclockwise but do not remove them until the wheel is raised off the ground.

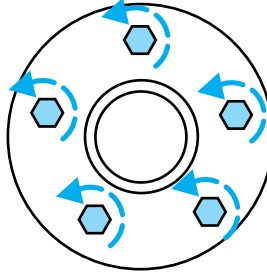

**STOP** Before placing the jack under the vehicle, NOTE the jack locations:

- **Front**

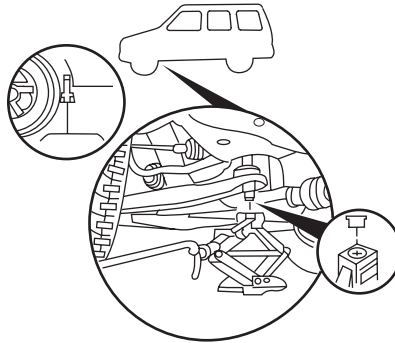

- **Rear**

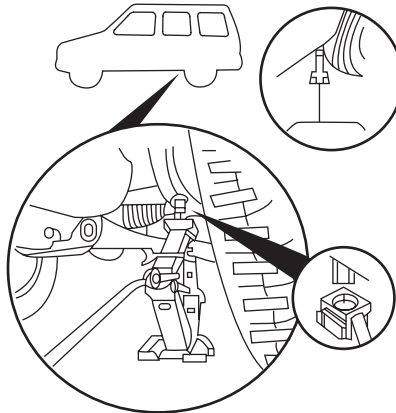

## Roadside Emergencies

- Lower the jack from its stored height to fit under the jacking notches. Position the jack according to the following guides and turn the jack handle clockwise until the tire is a maximum of 1 inch (25 mm) off the ground.

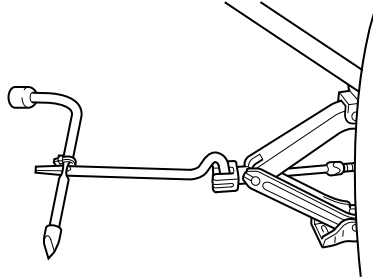

**Never use the differentials as a jacking point.**

**WARNING:** To lessen the risk of personal injury, do not put any part of your body under the vehicle while changing a tire. Do not start the engine when your vehicle is on the jack. The jack is only meant for changing the tire.

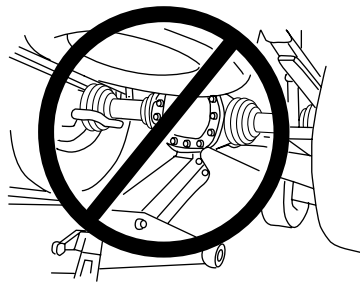

- Remove the lug nuts with the lug nut wrench.
- Replace the flat tire with the spare tire, making sure the valve stem is facing outward. Reinstall lug nuts until the wheel is snug against the hub. Do not fully tighten the lug nuts until the wheel has been lowered.
- Lower the wheel by turning the jack handle counterclockwise.
- Remove the jack and fully tighten the lug nuts in the order shown. Refer to *Wheel lug nut torque specifications* later in this chapter for the proper lug nut torque specification.

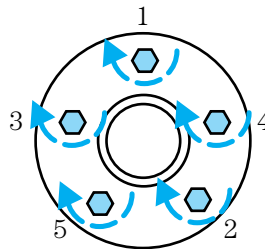

## Roadside Emergencies

### 14. Cargo management system (if equipped):

Reclip the tools onto the jack.

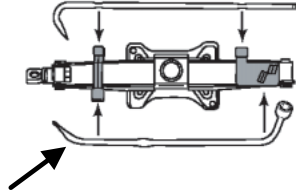

Reinstall the jack and tools in the cargo area. To replace the jack in the vehicle:

- guide the jack bottom first in the trim opening and position in the bracket (3),
- secure the retention clip on the upper part of the jack (2), and
- close and tighten the thumbscrew (1).

Make sure the jack is fastened so it does not rattle when you drive.

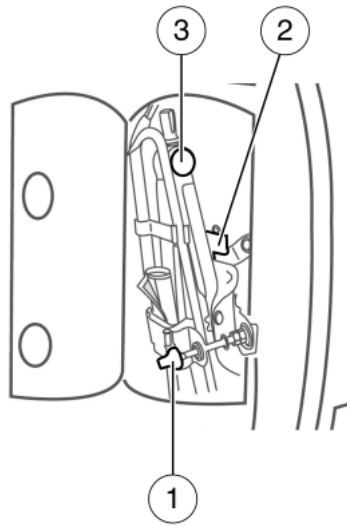

## Roadside Emergencies

### Non-cargo management system (if equipped):

- Reclip the tools onto the jack making sure that the tools are fully contained by the clips as shown.
- Reinstall the jack in the pocket with the left side first, then snap the right side down.
- Ensure that the hold-strap contains the jack and tools before snapping the buckle.
- Ensure that the jack and tools are oriented as illustrated.

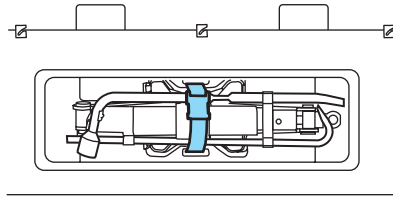

### Stowing the flat/spare tire

**Note:** Failure to follow spare tire stowage instructions may result in failure of cable or loss of spare tire.

**If you are stowing a tire that requires reattaching it to the vehicle with a tether, perform these steps first, then proceed with the steps following.**

1. Place tire on end with valve stem facing rearward, away from vehicle.
2. Place tether into bolt holes in wheel and attach lug nut using lug wrench.

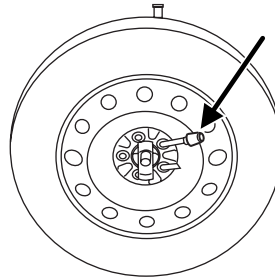

3. Lay the tire on the ground with the valve stem facing down. If your vehicle is equipped with aluminum wheels, remove the wheel center cap.
4. Slide the wheel partially under the vehicle and install the retainer through the center of the wheel.
5. Turn the jack handle clockwise until the tire is raised to its original position underneath the vehicle. The effort to turn the jack handle increases significantly as the tire contacts the frame. The spare tire carrier will ratchet when the tire is in the fully stowed position. The spare tire carrier has a built-in ratchet feature that will not allow you

## Roadside Emergencies

to overtighten. If the spare tire carrier ratchets with very little effort, take the vehicle to your authorized Mazda dealer for assistance at your earliest convenience. If your vehicle is equipped with a trailer hitch, guide the tire with one hand; keep the rear of the tire tilted down until the tire clears the bumper.

6. Check that the tire lies flat against the frame assembly. Push against the tire to make sure it is tightly seated under the vehicle. Loosen and retighten, if necessary. (Make sure that the tire does not contact the bumper.)

**WARNING: Failure to stow the spare tire may result in the failure of the winch cable and the loss of the spare tire. A loose tire on the highway is a very dangerous object to other people on the road. Check to be sure the tire is firmly mounted; go to a dealer to have it re-mounted if you have any doubt about spare tire security.**

7. Repeat this tightness check procedure when servicing the spare tire pressure (every six months), or at any time that the spare tire is disturbed through service of other components.

### WHEEL LUG NUT TORQUE SPECIFICATIONS

Retighten the lug nuts to the specified torque at 500 miles (800 km) after any wheel disturbance (tire rotation, changing a flat tire, wheel removal, etc.).

Bolt size	Wheel lug nut torque*	
	lb.ft.	N•m
M12 x 1.5	100	135

\* Torque specifications are for nut and bolt threads free of dirt and rust. Use only Mazda recommended replacement fasteners.

**WARNING: When a wheel is installed, always remove any corrosion, dirt or foreign materials present on the mounting surfaces of the wheel or the surface of the front disc brake hub and rotor that contacts the wheel. Installing wheels without correct metal-to-metal contact at the wheel mounting surfaces can cause the wheel nuts to loosen and the wheel to come off while the vehicle is in motion, resulting in loss of control.**

## Roadside Emergencies

### OVERHEATING

If the temperature gauge indicates overheating and you experience power loss, you hear a loud knocking or pinging noise, the engine is probably too hot.

If this happens:

1. Drive safely to the side of the road and park off the right-of-way.
2. Shift the automatic transmission into P (Park) or the manual transmission into the neutral position, and apply the parking brake.
3. Turn off the air conditioner.

**WARNING: Steam from an overheated engine is dangerous. The escaping steam could seriously burn you. Open the hood ONLY after steam is no longer escaping from the engine.**

4. Check whether coolant or steam is escaping from under the hood or from the engine compartment.
- **If steam is coming from the engine compartment:** do not go near the front of the vehicle. Stop the engine, then turn the ignition switch to the ON position without starting the engine. The radiator cooling fans will start to cool the engine.
  - **If neither coolant nor steam is escaping:** open the hood and idle the engine until it cools. If this does not lower the temperature, stop the engine and let it cool.
5. Check the coolant level. If it is low, look for leaks in the radiator hoses and connections, heater hoses and connections, radiator and water pump.

If you find a leak or other damage, or if coolant is still leaking, stop the engine and call an Authorized Mazda Dealer.

See *Adding coolant* in the *Maintenance and Specifications* section. If you find no problems, the engine is cool and no leaks are obvious, carefully add coolant as required.

**WARNING: When the engine and radiator are hot, scalding coolant and steam may shoot out under pressure and cause serious injury. Do not remove the cooling system cap when the engine and radiator are hot.**

**Note:** If the engine continues to overheat or frequently overheats, have the cooling system inspected. The engine could be seriously damaged unless repairs are made.



## Roadside Emergencies

### JUMP STARTING

**WARNING:** The gases around the battery can explode if exposed to flames, sparks, or lit cigarettes. An explosion could result in injury or vehicle damage.

**Do not push start your vehicle. You could damage the catalytic converter.**

**WARNING:** Batteries contain sulfuric acid which can burn skin, eyes and clothing, if contacted.

**Do not attempt to push start your vehicle. Automatic transmissions do not have push-start capability.**

### Preparing your vehicle

When the battery is disconnected or a new battery is installed, the transmission must relearn its shift strategy. As a result, the transmission may have firm and/or soft shifts. This operation is considered normal and will not affect function or durability of the transmission. Over time, the adaptive learning process will fully update transmission operation.

- **Use only a 12-volt supply to start your vehicle.**
- Do not disconnect the battery of the disabled vehicle as this could damage the vehicle's electrical system.
- Park the booster vehicle close to the hood of the disabled vehicle making sure the two vehicles **do not** touch. Set the parking brake on both vehicles and stay clear of the engine cooling fan and other moving parts.
- Check all battery terminals and remove any excessive corrosion before you attach the battery cables. Ensure the vent caps are tight and level.
- Turn the heater fan on in both vehicles to protect any electrical surges. Turn all other accessories off.

## Roadside Emergencies

### Connecting the jumper cables

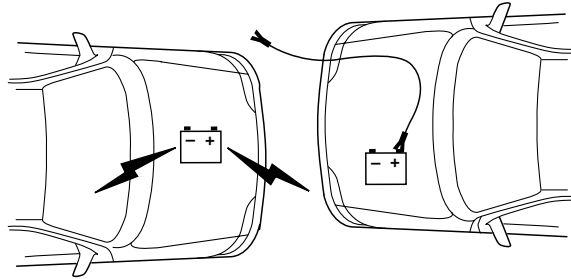

1. Connect the positive (+) jumper cable to the positive (+) terminal of the discharged battery.

**Note:** In the illustrations, *lightning bolts* are used to designate the assisting (boosting) battery.

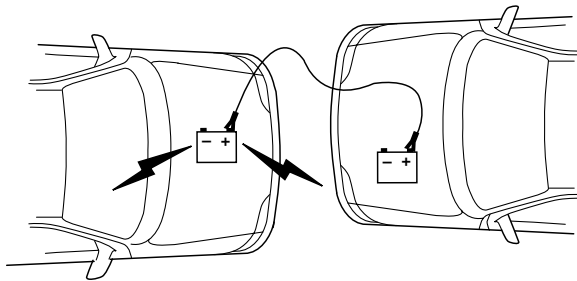

2. Connect the other end of the positive (+) cable to the positive (+) terminal of the assisting battery.

## Roadside Emergencies

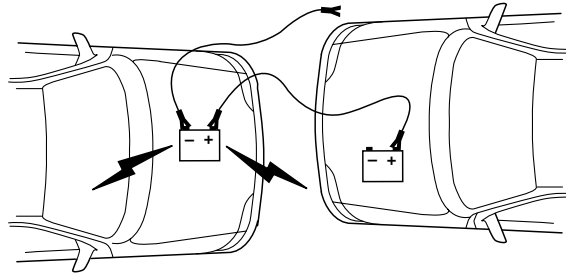

3. Connect the negative (-) cable to the negative (-) terminal of the assisting battery.

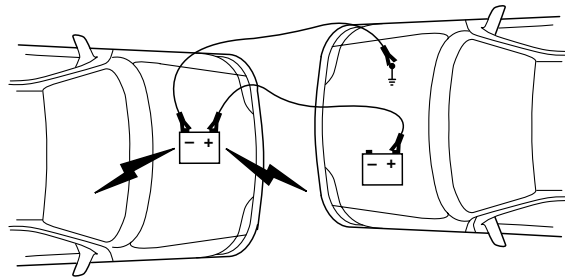

4. Make the final connection of the negative (-) cable to an exposed metal part of the disabled vehicle's engine, away from the battery and the fuel injection system. **NOTE: Do not** use fuel lines, engine rocker covers or the intake manifold as *grounding* points.

**WARNING: Do not connect the end of the second cable to the negative (-) terminal of the battery to be jumped. A spark may cause an explosion of the gases that surround the battery.**

5. Ensure that the cables are clear of fan blades, belts, moving parts of both engines, or any fuel delivery system parts.

### Jump starting

1. Start the engine of the booster vehicle and run the engine at moderately increased speed.
2. Start the engine of the disabled vehicle.
3. Once the disabled vehicle has been started, run both engines for an additional three minutes before disconnecting the jumper cables.

## Roadside Emergencies

### Removing the jumper cables

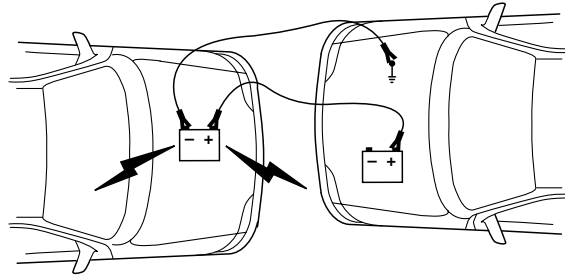

**Remove the jumper cables in the reverse order that they were connected.**

1. Remove the jumper cable from the *ground* metal surface.

**Note:** In the illustrations, *lightning bolts* are used to designate the assisting (boosting) battery.

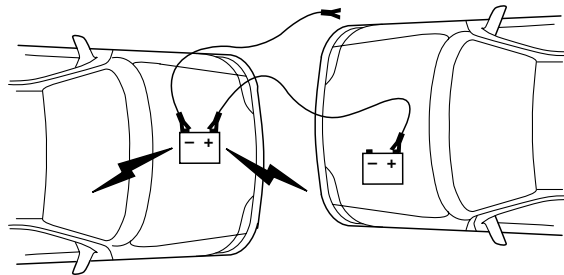

2. Remove the jumper cable on the negative (-) connection of the booster vehicle's battery.

## Roadside Emergencies

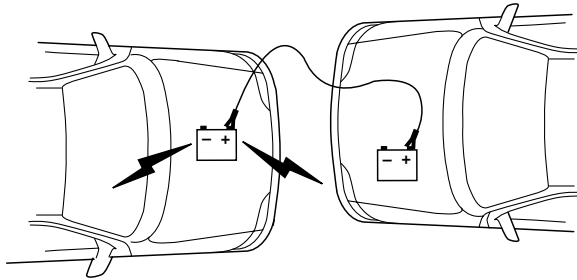

3. Remove the jumper cable from the positive (+) terminal of the booster vehicle's battery.

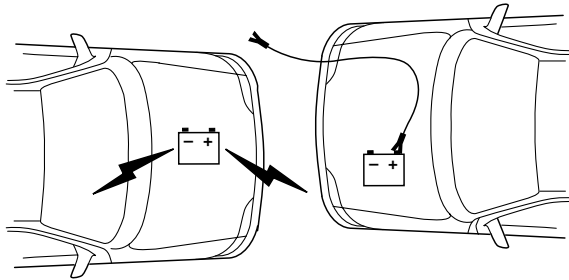

4. Remove the jumper cable from the positive (+) terminal of the disabled vehicle's battery.

After the disabled vehicle has been started and the jumper cables removed, allow it to idle for several minutes so the engine computer can *relearn* its idle conditions.

## Roadside Emergencies

### WRECKER TOWING

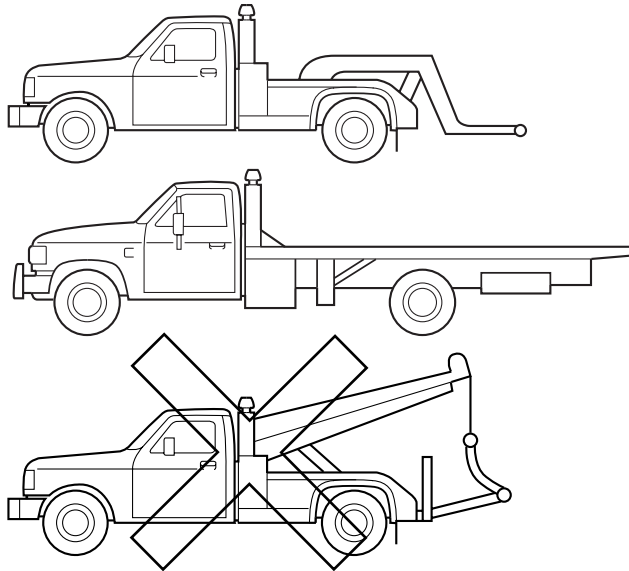

If you need to have your vehicle towed, contact a professional towing service or, if you are a member of a roadside assistance program, your roadside assistance service provider.

It is recommended that your vehicle be towed with a wheel lift and dollies or flatbed equipment. Do not tow with a slingbelt. Mazda has not approved a slingbelt towing procedure.

If your vehicle is to be towed from the rear using wheel lift equipment, it is recommended that the front wheels (drive wheels) be placed on a dolly to prevent damage to the automatic transaxle.

On 4WD vehicles, it is **required** that your vehicle be towed with a wheel lift and dollies or flatbed equipment with all the wheels off the ground.

**If the vehicle is towed by other means or incorrectly, vehicle damage may occur.**

## Roadside Emergencies

In case of a roadside emergency with a disabled vehicle (without access to wheel dollies, car hauling trailer or flatbed transport vehicle) your vehicle (regardless of powertrain configuration) can be flat towed (all wheels on the ground) under the following conditions:

- Place the transmission in N (Neutral).
- Maximum distance is 50 miles (80 km).
- Maximum speed is 35 mph (56 km/h).

## Customer Assistance

### **CUSTOMER ASSISTANCE (U.S.A. MAINLAND AND HAWAII)**

Your complete and permanent satisfaction is our business. We are here to serve you. All Authorized Mazda Dealers have the knowledge and the tools to keep your Mazda vehicle in top condition.

If you have any questions or recommendations for improvement regarding the service of your Mazda vehicle or servicing by Mazda Dealer personnel, we recommend that you take the following steps:

#### **STEP 1: Contact Your Mazda Dealer**

Discuss the matter with an Authorized Mazda Dealer. This is the quickest and best way to address the issue. If your concern has not been resolved by the CUSTOMER RELATIONS, SALES, SERVICE, or PARTS MANAGER, then please contact the GENERAL MANAGER of the dealership or the OWNER.

#### **STEP 2: Contact Mazda North American Operations**

If for any reason you feel the need for further assistance after contacting your dealership management, you can reach Mazda North American Operations by one of the following ways:

Log on at: [www.mazdaUSA.com](http://www.mazdaUSA.com).

Answers to many questions, including how to locate or contact a local Mazda Dealership in the U.S., can be found here.

By email at: [www.mazdaUSA.com](http://www.mazdaUSA.com) (Click on CONTACT US at the bottom of the home page).

By phone at: 1 (800) 222-5500

By letter at:

Attn: Customer Assistance  
Mazda North American Operations  
7755 Irvine Center Drive  
Irvine, CA 92618-2922  
P.O. Box 19734  
Irvine, CA 92623-9734

Whatever way you contact us, please help us to serve you more efficiently and effectively by providing the following information:

1. Your name, address, and telephone number
2. Year and model of vehicle
3. Vehicle Identification Number (17 digits, noted on your registration or title or located on the upper driver's side corner of the dash)
4. Purchase date and current mileage

200



## Customer Assistance

5. Your dealer's name and location
6. Your question(s)

If you live outside the U.S.A., please contact your nearest Mazda Distributor.

### **CUSTOMER ASSISTANCE (CANADA)**

Your complete and permanent satisfaction is our business. We are here to serve you. All Authorized Mazda Dealers have the knowledge and the tools to keep your Mazda vehicle in top condition.

In our experience, any questions, problems or complaints regarding the operation of your Mazda or any other general service transactions are most effectively resolved by your dealer. If the cause of your dissatisfaction cannot adequately be addressed by normal dealership procedures, we recommend that you take the following steps:

#### **STEP 1: Contact Your Mazda Dealer**

Discuss the matter with a member of dealership management. If the Service Manager has already reviewed your concerns, contact the owner of the dealership or its General Manager.

#### **STEP 2: Call the Mazda Regional Office**

If you feel that you still require assistance, ask the dealer Service Manager to arrange for you to meet the local Mazda Service Representative. If more expedient, contact Mazda Canada Inc. Regional Office nearest you for such arrangements.

#### **STEP 3: Contact the Mazda Customer Relations Department**

If still not substantially satisfied, contact the Customer Relations Department, Mazda Canada Inc., 55 Vogell Road, Richmond Hill, Ontario L4B 3K5 Canada TEL: 1 (800) 263-4680.

Provide the Department with the following information:

1. Your name, address, and telephone number
2. Year and model of vehicle
3. Vehicle Identification Number (VIN). Refer to *Vehicle identification label* in the *Maintenance and Specifications* chapter of this manual for the location of the VIN.
4. Purchase date.
5. Present odometer reading.
6. Your dealer's name and location
7. The nature of your problem and/or cause of dissatisfaction.

## Customer Assistance

The Department, in cooperation with the local Mazda Service Representative, will review the case to determine if everything possible has been done to ensure your satisfaction.

Please recognize that the resolution of service problems in most cases requires the use of your Mazda dealer's service facilities, personnel and equipment. We urge you to follow the above three steps in sequence therefore for most effective results.

### Mediation/Arbitration Program

Occasionally a customer concern cannot be resolved through Mazda's Customer Satisfaction Program. If after exhausting procedures in this manual, your concern is still not resolved, you have another option.

Mazda Canada Inc. participates in an arbitration program administered by the Canadian Motor Vehicle Arbitration Plan (CAMVAP). CAMVAP will advise you about how your concern may be reviewed and resolved by an independent third party through binding arbitration.

Your complete satisfaction is the goal of Mazda Canada Inc. and our dealers. Mazda's participation in CAMVAP makes a valuable contribution to our achieving that goal. There is no charge for using CAMVAP. CAMVAP results are fast, fair and final as the award is binding on both you and Mazda Canada Inc.

### Canadian Motor Vehicle Arbitration Plan (CAMVAP)

For vehicles delivered to authorized Canadian dealerships. If a specific item of concern arises, where a solution cannot be reached between an owner, Mazda, and/or one of its dealers (that all parties cannot agree upon), the owner may wish to use the services offered by the Canadian Motor Vehicle Arbitration Plan (CAMVAP).

CAMVAP uses the services of Provincial Administrators to assist consumers in scheduling and preparing for their arbitration hearings. However, before you can proceed with CAMVAP you must follow your Mazda dispute resolution process as outlined previously.

CAMVAP is fully implemented in all provinces and territories. Consumers wishing to obtain further information about the Program can obtain an information booklet from their dealer, the Provincial Administrator at 1 (800) 207-0685, or by contacting the Canadian Motor Vehicle Arbitration Office At:

235 Yorkland Boulevard, Suite 407  
North York, Ontario  
M2J 4Y8  
<http://camvap.ca>

202

## Customer Assistance

### Regional Offices

Regional Offices	Areas Covered
Mazda Canada Inc. Western Region 8171 Ackroyd Road Suite 2000 Richmond, B.C. V6X 3K1 (604) 303-5670	Alberta, British Columbia, Manitoba, Saskatchewan, Yukon
Mazda Canada Inc. Central Region 55 Vogell Road Richmond Hill, Ontario. L4B 3K5 1 (800) 263-4680	Ontario
Mazda Canada Inc. Quebec Region/Atlantic Region 6111 Route Trans Canadienne Pointe Claire, Quebec H9R 5A5 (514) 694-6390	Quebec, New Brunswick, Nova Scotia, Prince Edward Island, Newfoundland

### CUSTOMER ASSISTANCE (PUERTO RICO)

Your complete and permanent satisfaction is our business. That is why all Authorized Mazda Dealers have the knowledge and the tools to keep your Mazda vehicle in top condition.

If you have any questions or recommendations for improvement regarding the service of your Mazda vehicle or servicing by Mazda Dealer personnel, we recommend that you take the following steps:

#### **STEP 1**

Discuss the matter with an Authorized Mazda Dealer. This is the quickest and best way to address the issue. If your concern has not been resolved by the CUSTOMER RELATIONS, SALES, SERVICE, or PARTS MANAGER, then please contact the GENERAL MANAGER of the dealership or the OWNER.

## Customer Assistance

### STEP 2

If, after following STEP 1, you feel the need for further assistance, please contact your area's Mazda representative (Indicated on the next page).

Please help us by providing the following information:

1. Your name, address, and telephone number
2. Year and model of vehicle
3. Vehicle Identification Number (17 digits, noted on your registration or title or located on the upper driver's side corner of the dash)
4. Purchase date and current mileage
5. Your dealer's name and location
6. Your question(s)

If you would like to write a letter, please address it to the following,  
Attn: Customer Assistance

Plaza Motors Corp.

Mazda de Puerto Rico  
P.O. Box 362722  
San Juan, Puerto Rico  
00936-2722  
Tel: (787) 788-9300

This way, we can be sure to respond to you as efficiently as possible.  
That is our goal.

If you live outside the U.S.A., please contact your nearest Mazda  
Distributor.

### IN CALIFORNIA (U.S. ONLY)

California Civil Code Section 1793.2(d) requires that, if a manufacturer or its representative is unable to repair a motor vehicle to conform to the vehicle's applicable express warranty after a reasonable number of attempts, the manufacturer shall be required to either replace the vehicle with one substantially identical or repurchase the vehicle and reimburse the buyer in an amount equal to the actual price paid or payable by the consumer (less a reasonable allowance for consumer use). The consumer has the right to choose whether to receive a refund or replacement vehicle.

California Civil Code Section 1793.22(b) presumes that the manufacturer has had a reasonable number of attempts to conform the vehicle to its applicable express warranties if, within the first 18 months of ownership of a new vehicle or the first 18,000 miles (29,000 km), whichever occurs first:

204

## Customer Assistance

1. Two or more repair attempts are made on the same nonconformity likely to cause death or serious bodily injury OR
2. Four or more repair attempts are made on the same nonconformity (a defect or condition that substantially impairs the use, value or safety of the vehicle) OR
3. The vehicle is out of service for repair of nonconformities for a total of more than 30 calendar days (not necessarily all at one time).

In the case of 1 or 2 above, the consumer must also notify the manufacturer of the need for the repair of the nonconformity at the following address:

Mazda North American Operations  
7755, Irvine Center Drive  
Irvine, CA 92618-2922

### **MAZDA IMPORTERS/DISTRIBUTORS**

#### **U.S.A (Importer/Distributor)**

##### **Mazda North American Operations**

7755 Irvine Center Drive  
Irvine, CA 92618-2922  
P.O. Box 19734  
Irvine, CA 92623-9734  
TEL: 1 (800) 222-5500 (in U.S.A.)  
(949) 727-1990 (outside U.S.A.)

#### **(Distributor in each area)**

### **CANADA**

#### **Mazda Canada, Inc.**

55 Vogell Road  
Richmond Hill, Ontario L4B 3K5 Canada  
TEL: 1 (800) 263-4680 (in Canada)  
(416) 609-9909 (outside Canada)

### **PUERTO RICO**

#### **Plaza Motors Corp. (Mazda de Puerto Rico)**

P.O. Box 362722, San Juan, Puerto Rico 00936-2722  
TEL: (787) 788-9300

### **GUAM**

#### **(d.b.a. Triple J. Enterprises, Inc.)**

P.O. Box 6066 Tamuning, Guam  
TEL: (671) 646-9216

## Customer Assistance

### SAIPAN

**Pacific International Marianas, Inc.  
(d.b.a. Midway Motors)**

P.O. Box 887 Saipan, MP 96950  
TEL: (670) 234-7524

**Triple J Saipan, Inc.  
(d.b.a. Triple J Motors)**

Beach Road  
Chalan LauLau  
Saipan, MP 96950  
TEL: (670) 235-4868

### AMERICAN SAMOA

**Polynesia Motors, Inc.**

P.O. Box 1120, Pago Pago, American Samoa 96799  
TEL: (684) 699-1854

### WARRANTIES FOR YOUR MAZDA

- New Vehicle Limited Warranty
- Safety Restraint System Limited Warranty
- Anti-perforation Limited Warranty
- Federal Emission Control Warranty
  - Emission Defect Warranty
  - Emission Performance Warranty
- California Emission Control Warranty (if applicable)
- Replacement Parts and Accessories Limited Warranty
- Tire Warranty

**NOTE:** Detailed warranty information is provided with your Mazda portfolio.

### Outside the United States

Government regulations in the United States require that automobiles meet specific emission regulations and safety standards. Therefore, vehicles built for use in the United States, may differ from those sold in other countries.

The differences may make it difficult or even impossible for your vehicle to receive satisfactory servicing in other countries. We strongly recommend that you NOT take your Mazda outside the United States.

206

## Customer Assistance

However, in the event that you are moving to Canada permanently, Mazda vehicles built for use in the United States could be eligible for exportation to Canada with specific vehicle modifications to comply with the Canadian Motor Vehicle Safety requirements.

Special Note: The above is applicable for permanent import/export situations and not related to travelers on vacation.

You may have the following problems if you do take your vehicle outside of the United States:

- Recommended fuel may be unavailable. Any kind of leaded fuel or low-octane fuel will affect vehicle performance and damage the emission controls and engine.
- Proper repair facilities, tools, testing equipment, and replacement parts may not be available.

Please refer to your manufacturers warranty booklet for more information.

### Outside Canada

Government regulations in Canada require that automobiles meet specific emission regulations and safety standards. Therefore, vehicles built for use in Canada, may differ from those sold in other countries.

The differences may make it difficult or even impossible for your vehicle to receive satisfactory servicing in other countries. We strongly recommend that you NOT take your Mazda outside Canada. However, in the event that you are moving to the United States permanently, Mazda vehicles built for use in Canada could be eligible for exportation to the United States with specific vehicle modifications to comply with the United States Federal Motor Vehicle Safety requirements.

Special Note: The above is applicable for permanent import/export situations and not related to travelers on vacation.

You may have the following problems if you do take your vehicle outside of Canada:

- Recommended fuel may be unavailable. Any kind of leaded fuel or low-octane fuel will affect vehicle performance and damage the emission controls and engine.
- Proper repair facilities, tools, testing equipment, and replacement parts may not be available.

Please refer to your manufacturers warranty booklet for more information.

## Customer Assistance

### ADD-ON NON-GENUINE PARTS AND ACCESSORIES

Non-genuine parts and accessories for Mazda vehicles can be found in stores. These may fit your vehicle, but they are not approved by the manufacturer for use with Mazda vehicles. When you install non-genuine parts or accessories, they could affect your vehicle's performance or safety system; the manufacturer's warranty doesn't cover this. Before you install any non-genuine parts or accessories, consult an Authorized Mazda Dealer.

**WARNING: Installation of Non-Genuine Parts or Accessories: Installation of non-genuine parts or accessories could be dangerous. Improperly designed parts or accessories could seriously affect your vehicle's performance or safety system. This could cause you to have an accident or increase your chances of injuries in an accident. Always consult an Authorized Mazda Dealer before you install non-genuine parts or accessories.**

**WARNING: Add-On Electrical and Electronic Equipment: Incorrectly choosing or installing improper add-on equipment or choosing an improper installer could be dangerous. Essential systems could be damaged, causing engine stalling, air-bag (SRS) activation, ABS inactivation, or a fire in the vehicle. Be very careful in choosing and installing add-on electrical equipment, such as mobile telephones, two-way radios, stereo systems, and car alarm systems.**

Mazda assumes no responsibility for death, injury, or expenses that may result from the installation of add-on non-genuine parts or accessories.

### SERVICE PUBLICATIONS

Factory-authorized Mazda service publications are available for owners who wish to do some of their own maintenance and repair.

When requesting any of our publications through an Authorized Mazda Dealer, refer to the chart below.

If they don't have what you need in stock, they can order it for you.



## Customer Assistance

PUBLICATION ORDER NUMBER	PUBLICATION DESCRIPTION
9999 95 062B 06	WORKSHOP MANUAL
9999 95 038G 06	WIRING DIAGRAM
9999 95 014C 06R	OWNER'S MANUAL

### **WORKSHOP MANUAL:**

Covers recommended maintenance and repair procedures of the drive train, body and chassis.

### **WIRING DIAGRAM:**

Provides electrical schematics as well as component location for the entire electrical system.

### **OWNER'S MANUAL:**

This booklet contains information regarding the proper care and operation of your vehicle. This is not a technician's manual.

**Please note that your Authorized Mazda Dealership has trained personnel and special service tools to correctly and safely maintain Mazda vehicles.**

### **REPORTING SAFETY DEFECTS**

If you believe that your vehicle has a defect which could cause a crash or could cause injury or death, you should immediately inform the National Highway Traffic Safety Administration (NHTSA) in addition to notifying your Mazda importer/distributor.

If NHTSA receives similar complaints, it may open an investigation, and if it finds that a safety defect exists in a group of vehicles, it may order a recall and remedy campaign. However NHTSA cannot become involved in individual problems between you, your dealer, or your Mazda importer/distributor).

To contact NHTSA, you may either call the Auto Safety Hotline toll-free at 1-800-424-9393 (or 366-0123 in the Washington D.C. area) or write to:

NHTSA  
400 Seventh Street  
U.S. Department of Transportation  
Washington, D.C. 20590

You can also obtain other information about motor vehicle safety from the Hotline.

## Customer Assistance

(Note)

If you live in the U.S.A., all correspondence to:

Mazda North American Operations  
7755, Irvine Center Drive  
Irvine, California 92618-2922  
P.O. Box 19734  
Irvine, CA 92623-9734  
Customer Assistance Center  
or toll free at 1 (800) 222-5500

If you live outside of the U.S.A., please contact the nearest Mazda Distributor. See the *Mazda importers/distributors* section in this chapter.

### WASHING THE EXTERIOR

Wash your vehicle regularly with cool or lukewarm water and a neutral pH shampoo, such as an approved shampoo available from your Mazda dealer.

- Never use strong household detergents or soap, such as dish washing or laundry liquid. These products can discolor and spot painted surfaces.
- Never wash a vehicle that is “hot to the touch” or during exposure to strong, direct sunlight.
- Always use a clean sponge or car wash mitt with plenty of water for best results.
- Dry the vehicle with a chamois or soft terry cloth towel in order to eliminate water spotting.
- It is especially important to wash the vehicle regularly during the winter months, as dirt and road salt are difficult to remove and cause damage to the vehicle.
- Immediately remove items such as gasoline, diesel fuel, bird droppings and insect deposits because they can cause damage to the vehicle’s paintwork and trim over time.
- Remove any exterior accessories, such as antennas, before entering a car wash.
- **Suntan lotions and insect repellents can damage any painted surface; if these substances come in contact with your vehicle, wash off as soon as possible.**

### WAXING

Applying Mazda Paint Sealant (ZC-45) to your vehicle every six months will assist in reducing minor scratches and paint damage.

- Wash the vehicle first.
- Do not use waxes that contain abrasives; use Mazda Premium Liquid Wax (ZC-53-A), which is available from your dealer, or an equivalent quality product.
- Do not allow paint sealant to come in contact with any non-body (low-gloss black) colored trim, such as grained door handles, roof racks, bumpers, side moldings, mirror housings or the windshield cowl area. The paint sealant will “gray” or stain the parts over time.

## Cleaning

### PAINT CHIPS

Your dealer has touch-up paint to match your vehicle's color. Touch-up paint can be used to repair minor scratches to painted surfaces.

- Remove particles such as bird droppings, tree sap, insect deposits, tar spots, road salt and industrial fallout before repairing paint chips.
- Always read the instructions before using the products.

### ALUMINUM WHEELS AND COVERS

Aluminum wheel rims or covers are coated with a clearcoat paint finish. In order to maintain their shine:

- Clean with One Step Wash and Wax Concentrate, which is available from your authorized Mazda dealer.
- Never apply any cleaning chemical to hot or warm wheel rims or covers.
- Some automatic car washes may cause damage to the finish on your wheel rims or covers. Chemical-strength cleaners, or cleaning chemicals, in combination with brush agitation to remove brake dust and dirt, could wear away the clearcoat finish over time.
- Do not use hydrofluoric acid-based or high caustic-based wheel cleaners, steel wool, fuels or strong household detergent.
- To remove tar and grease, use Extra Strength Tar and Road Oil Removal, available from your authorized Mazda dealer.

### ENGINE

Engines are more efficient when they are clean because grease and dirt buildup keep the engine warmer than normal. When washing:

- Take care when using a power washer to clean the engine. The high-pressure fluid could penetrate the sealed parts and cause damage.
- Never spray the engine or other engine components with water. Water will damage the engine or other engine components.
- Spray Engine Shampoo and Degreaser, available at your authorized Mazda dealer, on all parts that require cleaning and pressure rinse clean.
- Cover the highlighted areas to prevent water damage when cleaning the engine.

212

## Cleaning

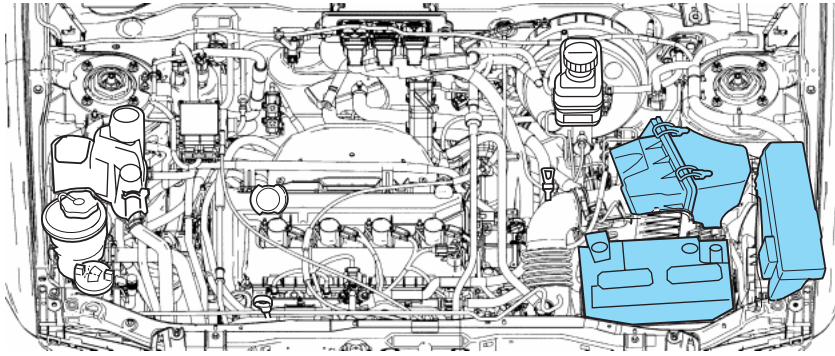

- **2.3L DOHC I4 Engine**

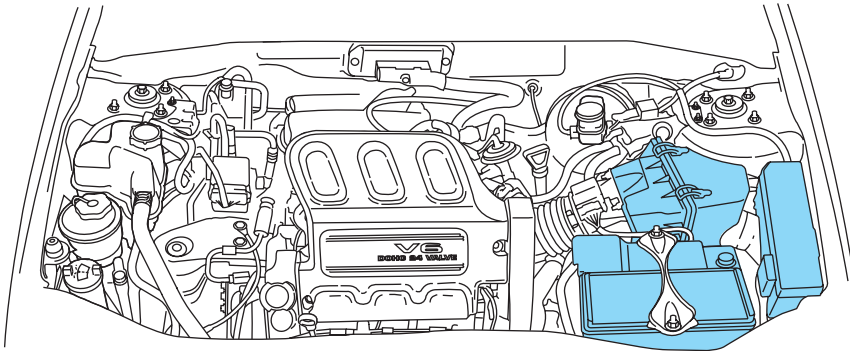

- **3.0L DOHC V6 Engine**

- Never wash or rinse the engine while it is running; water in the running engine may cause internal damage.

### **PLASTIC (NON-PAINTED) EXTERIOR PARTS**

Use only approved products to clean plastic parts. These products are available from your dealer.

- For routine cleaning, use One Step Wash and Wax Concentrate, available at your authorized Mazda dealer.
- If tar or grease spots are present, use Extra Strength Tar and Road Oil Removal, available at your authorized Mazda dealer.

## Cleaning

### WINDOWS AND WIPER BLADES

The windshield, rear window and wiper blades should be cleaned regularly. If the wiper does not wipe properly, substances on the windshield, rear window or the wiper blades may be the cause. These may include hot wax treatments used by commercial car washes, tree sap, or other organic contamination. To clean these items, please follow these tips:

- The windshield or rear window may be cleaned with a non-abrasive cleaner such as Ultra Clear Spray Glass Cleaner, available from your authorized Mazda dealer.
- Do not use abrasives, as they may cause scratches.
- Do not use fuel, kerosene, or paint thinner to clean any parts.
- Wiper blades can be cleaned with isopropyl (rubbing) alcohol or windshield washer solution. Be sure to replace wiper blades when they appear worn or do not function properly.

### INSTRUMENT PANEL AND CLUSTER LENS

Clean the instrument panel with a damp cloth, then with a clean, dry cloth, or use Mazda Dash & Vinyl Cleaner (ZC-38-A).

- Avoid cleaners or polish that increase the gloss of the upper portion of the instrument panel. The dull finish in this area helps protect the driver from undesirable windshield reflection.

**WARNING: Do not use chemical solvents or strong detergents when cleaning the steering wheel or instrument panel to avoid contamination of the air bag system.**

- Be certain to wash or wipe your hands clean if you have been in contact with certain products such as insect repellent and suntan lotion in order to avoid possible damage to the interior painted surfaces.

### INTERIOR TRIM

- Clean the interior trim areas with a damp cloth, then with a clean, dry cloth; you may also use Mazda Dash & Vinyl Cleaner (ZC-38-A).
- Do not use household or glass cleaners as these may damage the finish.

## Cleaning

### INTERIOR

For fabric, carpets, cloth seats, safety belts and seats equipped with side air bags (if equipped):

- Remove dust and loose dirt with a vacuum cleaner.
- Remove light stains and soil with Extra Strength Upholstery Cleaner, available at your authorized Mazda dealer.
- If grease or tar is present on the material, spot-clean the area first with Spot and Stain Remover, available at your authorized Mazda dealer.
- If a solvent ring forms on the fabric after spot cleaning, clean the entire area immediately (but do not oversaturate) or the ring will set.
- Do not use household cleaning products or glass cleaners, which can stain and discolor the fabric and affect the flame retardant abilities of the seat materials.

**WARNING: Do not use chemical solvents or strong detergents when cleaning the seat where the side air bag (if equipped) is mounted. Such products may contaminate the side air bag system (if equipped) and affect performance of the side air bag (if equipped) in a collision. The air bag may not function correctly and not provide any injury reduction benefits.**

### LEATHER SEATS (IF EQUIPPED)

Your leather seating surfaces have a clear, protective coating over the leather.

- To clean, use a soft cloth with Deluxe Leather and Vinyl Cleaner. Dry the area with a soft cloth.
- To help maintain its resiliency and color, use the Deluxe Leather Care Kit, available at your authorized Mazda dealer.
- Do not use household cleaning products, alcohol solutions, solvents or cleaners intended for rubber, vinyl and plastics, or oil/petroleum-based leather conditioners. These products may cause premature wearing of the clear, protective coating.

### UNDERBODY

Flush the complete underside of your vehicle frequently. Keep body and door drain holes free from packed dirt.

## Cleaning

### **MAZDA CAR CARE PRODUCTS**

Your Mazda dealer has many quality products available to clean your vehicle and protect its finishes. These quality products have been specifically engineered to fulfill your automotive needs; they are custom designed to complement the style and appearance of your vehicle. Each product is made from high quality materials that meet or exceed rigid specifications. For best results, use these products or products of equivalent quality. These products are available at your authorized Mazda dealer.



## Maintenance and Specifications

### INTRODUCTION

Be extremely careful to prevent injury to yourself and others or damage to your vehicle when using this manual for inspection and maintenance.

If you're unsure about any procedure it describes, we strongly urge you to have a reliable and qualified service shop perform the work, preferably an authorized Mazda Dealer.

Factory-trained Mazda technicians and genuine Mazda parts are best for your vehicle. Without this expertise and the parts that have been designed and made especially for your Mazda, inadequate, incomplete, and insufficient servicing may result in problems. This could lead to vehicle damage or an accident and injuries.

For expert advice and quality service, consult an authorized Mazda Dealer.

The owner should retain evidence that proper maintenance has been performed as prescribed.

Claims against the warranty resulting from lack of maintenance, as opposed to defective materials or authorized Mazda workmanship, will not be honored.

Any auto repair shop using parts equivalent to your Mazda's original equipment may perform maintenance. **But we recommend that it always be done by an authorized Mazda Dealer using genuine Mazda parts.**

### SCHEDULED MAINTENANCE

Follow Schedule 1 if the vehicle is operated mainly where none of the following conditions apply.

If any do apply, follow Schedule 2 (Canada and Puerto Rico residents follow Schedule 2).

- Repeated short-distance driving
- Driving in dusty conditions
- Driving with an extended use of brakes
- Driving in areas where salt or other corrosive materials are being used
- Driving on rough or muddy roads
- Extended periods of idling or low-speed operation
- Driving for long periods in cold temperatures or extremely humid climates
- Towing a trailer or using a car-top carrier

## Maintenance and Specifications

**NOTE:** After the described period, continue to follow the described maintenance at the recommended intervals.

### SCHEDULE 1

**I:** Inspect and repair, clean, adjust, or replace if necessary  
(Oil-permeated air filter cannot be cleaned using the air-blow method)

**R:** Replace

**L:** Lubricate

Maintenance Item	Maintenance Interval (Number of months or km (miles), whichever comes first)												
	Months	6	12	18	24	30	36	42	48	54	60	66	72
	x 1000 Km	12	24	36	48	60	72	84	96	108	120	132	144
(x 1000 Miles)	(7.5)	(15)	(22.5)	(30)	(37.5)	(45)	(52.5)	(60)	(67.5)	(75)	(82.5)	(90)	
<b>ENGINE</b>													
Engine valve clearance (for 2.3L engine)	Audible inspect every 120,000 km (75,000 miles), if noisy, adjust												
Engine oil	R	R	R	R	R	R	R	R	R	R	R	R	R
Oil filter	R	R	R	R	R	R	R	R	R	R	R	R	R
Drive belts (tension)	2.3L engine					I					I		
	3.0L engine				I				I				I
PCV valve (for 3.0L engine) *1	Replace every 160,000 km (100,000 miles)												
<b>IGNITION SYSTEM</b>													
Spark plugs	Replace every 120,000 km (75,000 miles)												
<b>FUEL SYSTEM</b>													
Air cleaner filter						R					R		
Fuel filter *1				R					R				R
Fuel lines and hoses *1				I					I				I
Hoses and tubes for emission *1									I				
<b>COOLING SYSTEM</b>													
Cooling system and hoses				I					I				I
Engine coolant (yellow)	Replace at first 160,000 km (100,000 miles) or 60 months; after that, every 80,000 km (50,000 miles) or 36 months												
Engine coolant level	I	I	I	I	I	I	I	I	I	I	I	I	I

## Maintenance and Specifications

Maintenance Item	Maintenance Interval (Number of months or km (miles), whichever comes first)													
	Months	6	12	18	24	30	36	42	48	54	60	66	72	
	x 1000 Km	12	24	36	48	60	72	84	96	108	120	132	144	
	(x 1000 Miles)	(7.5)	(15)	(22.5)	(30)	(37.5)	(45)	(52.5)	(60)	(67.5)	(75)	(82.5)	(90)	
<b>CHASSIS and BODY</b>														
Brake lines, hoses and connections					I				I					I
Disc brakes		I			I		I		I		I			I
Drum brakes					I				I					I
Tire (rotation), check wheel lug nut torque *3	Rotate every 12,000 km (7,500 miles)													
Tire inflation and wear	I	I	I	I	I	I	I	I	I	I	I	I	I	I
Steering operation and linkages					I				I					I
Power steering fluid level	I	I	I	I	I	I	I	I	I	I	I	I	I	I
Manual transaxle fluid														R
Automatic transaxle fluid	Replace every 240,000 km (150,000 miles)													
Rear differential fluid (4WD only) *2	Replace every 240,000 km (150,000 miles)													
Transfer case fluid (4WD only)	Replace every 240,000 km (150,000 miles)													
Front and rear suspension ball joints					I				I					I
Driveshaft dust boots					I				I					I
Bolts and nuts on chassis and body					I				I					I
Exhaust system heat shields					I				I					I
All locks and hinges	L	L	L	L	L	L	L	L	L	L	L	L	L	L
Washer fluid level	I	I	I	I	I	I	I	I	I	I	I	I	I	I

\*1 According to state and federal regulations, failure to perform maintenance on these items will not void your emissions warranties. However, Mazda recommends that all maintenance services be performed at the recommended time or miles (kilometers) period to ensure long-term reliability. Refer to *Fuel filter* in the *Maintenance and Specifications* chapter for fuel filter replacement requirements.

## Maintenance and Specifications

\*2 If this component has been submerged in water, the oil should be changed.

\*3 The wheel lug nuts must be retightened to the proper specifications at 500 miles (800 km) of new vehicle operation, at any wheel change, or at any other time the wheel lug nuts have been loosened. Refer to *Wheel Lug Nut Torque Specification* in the *Tires, Wheels and Loading* chapter for the proper lug nut torque specification.

### SCHEDULE 2

**I:** Inspect and repair, clean, adjust, or replace if necessary

(Oil-permeated air filter cannot be cleaned using the air-blow method)

**R:** Replace

**L:** Lubricate

Maintenance Item	Maintenance Interval (Number of months or km (miles), whichever comes first)												
	Months	4	8	12	16	20	24	28	32	36	40	44	48
	x 1000 Km	8	16	24	32	40	48	56	64	72	80	88	96
	(x 1000 Miles)	(5)	(10)	(15)	(20)	(25)	(30)	(35)	(40)	(45)	(50)	(55)	(60)
<b>ENGINE</b>													
Engine valve clearance (for 2.3L engine)	Audible inspect every 120,000 km (75,000 miles), if noisy, adjust												
Engine oil	R	R	R	R	R	R	R	R	R	R	R	R	R
Engine oil (for Puerto Rico)	Replace every 5,000 km (3,000 miles) (or 3 months)												
Oil filter	R	R	R	R	R	R	R	R	R	R	R	R	R
Drive belts (tension)	2.3L engine							I					
	3.0L engine						I						I
PCV valve (for 3.0L engine)	*1	Replace every 160,000 km (100,000 miles)											
<b>IGNITION SYSTEM</b>													
Spark plugs	USA	Replace every 96,000 km (60,000 miles)											
	Others *2	Replace every 120,000 km (75,000 miles)											
<b>FUEL SYSTEM</b>													
Air cleaner filter	Puerto Rico						R						R
	Others							R					
Fuel filter	*1						R						R
Fuel lines & hoses	*1						I						I

## Maintenance and Specifications

Maintenance Item	Maintenance Interval (Number of months or km (miles), whichever comes first)												
	Months	4	8	12	16	20	24	28	32	36	40	44	48
	x 1000 Km	8	16	24	32	40	48	56	64	72	80	88	96
	(x 1000 Miles)	(5)	(10)	(15)	(20)	(25)	(30)	(35)	(40)	(45)	(50)	(55)	(60)
Hoses and tubes for emission *1													I
<b>COOLING SYSTEM</b>													
Cooling system and hoses							I						I
Engine coolant (yellow)	Replace at first 160,000 km (100,000 miles) or 60 months; after that, every 80,000 km (50,000 miles) or 36 months												
Engine coolant level	I	I	I	I	I	I	I	I	I	I	I	I	I
<b>ELECTRICAL SYSTEM</b>													
Function of all lights	I	I	I	I	I	I	I	I	I	I	I	I	I
<b>CHASSIS and BODY</b>													
Brake lines, hoses and connections							I						I
Brake fluid level	I	I	I	I	I	I	I	I	I	I	I	I	I
Disc brakes			I				I			I			I
Drum brakes							I						I
Tire (rotation), check wheel lug nut torque *4	Rotate every 8,000 km (5,000 miles)												
Tire inflation pressure and tire wear	I	I	I	I	I	I	I	I	I	I	I	I	I
Steering operation and linkages							I						I
Power steering fluid level	I	I	I	I	I	I	I	I	I	I	I	I	I
Manual transaxle oil	Replace every 48,000 km (30,000 miles)												
Automatic transaxle fluid	Replace every 48,000 km (30,000 miles)												
Rear differential fluid (4WD only) *3	Replace every 160,000 km (100,000 miles)												
Transfer case fluid (4WD only) *3	Replace every 48,000 km (30,000 miles)												
Front and rear suspension ball joints							I						I
Driveshaft dust boots							I						I

## Maintenance and Specifications

Maintenance Item	Maintenance Interval (Number of months or km (miles), whichever comes first)													
	Months	4	8	12	16	20	24	28	32	36	40	44	48	
	x 1000 Km	8	16	24	32	40	48	56	64	72	80	88	96	
	(x 1000 Miles)	(5)	(10)	(15)	(20)	(25)	(30)	(35)	(40)	(45)	(50)	(55)	(60)	
Bolts and nuts on chassis and body			I				I			I			I	
Exhaust system heat shields							I						I	
All locks and hinges	L	L	L	L	L	L	L	L	L	L	L	L	L	
Washer fluid level	I	I	I	I	I	I	I	I	I	I	I	I	I	

\*1 According to state and federal regulations, failure to perform maintenance on these items will not void your emissions warranties. However, Mazda recommends that all maintenance services be performed at the recommended time or miles (kilometers) period to ensure long-term reliability. Refer to *Fuel filter* in the *Maintenance and Specifications* chapter for fuel filter replacement requirements.

\*2 If the vehicle is operated under any of the following conditions, change the spark plugs every 60,000 miles (96,000 km) or shorter.

- Repeated short-distance driving.
- Extended periods of idling or low-speed operation.
- Driving for long periods in cold temperatures or extremely humid climates.

\*3 If this component has been submerged in water, the oil should be changed.

\*4 The wheel lug nuts must be retightened to the proper specifications at 500 miles (800 km) of new vehicle operation, at any wheel change, or at any other time the wheel lug nuts have been loosened. Refer to *Wheel Lug Nut Torque Specification* in the *Tires, Wheels and Loading* chapter for the proper lug nut torque specification.

### OWNER MAINTENANCE SCHEDULE

The owner or a qualified service technician should make these vehicle inspections at the indicated intervals to ensure safe and dependable operation.

Bring any problem to the attention of an authorized Mazda Dealer or qualified service technician as soon as possible.

## Maintenance and Specifications

### When Refueling

- Brake and clutch fluid level
- Engine coolant level
- Engine oil level
- Washer fluid level

### At Least Monthly

- Tire inflation pressures

### At Least Twice a Year (For Example, Every Spring and Fall)

- Automatic transaxle fluid level
- Power steering fluid level

### Retightening lug nuts

- Retighten the lug nuts to the specified torque at 500 miles (800 km) after any wheel disturbance (tire rotation, changing a flat tire, wheel removal, etc.).
- Refer to *Wheel Lug Nut Torque Specification* in the *Tires, Wheels and Loading* chapter for the proper lug nut torque specification.

## SERVICE RECOMMENDATIONS

To help you service your vehicle:

- We highlight do-it-yourself items in the engine compartment for easy location.
- We provide *service maintenance section* which makes tracking routine service easy.

If your vehicle requires professional service, your dealership can provide necessary parts and service. Check your “Warranty Information” to find out which parts and services are covered.

Use only recommended fuels, lubricants, fluids and service parts conforming to specifications. Genuine Mazda parts are designed and built to provide the best performance in your vehicle.

## Maintenance and Specifications

### PRECAUTIONS WHEN SERVICING YOUR VEHICLE

**WARNING: A hot engine is dangerous. If the engine has been running, parts of the engine compartment can become very hot. You could be burned. Don't inspect the coolant system or add coolant when the engine is hot.**

- Do not work on a hot engine.
- Make sure that nothing gets caught in moving parts.
- Do not work on a vehicle with the engine running in an enclosed space, unless you are sure you have enough ventilation.
- Keep all open flames and other lit material away from the battery and all fuel related parts.

#### Working with the engine off

- Automatic transmission:
  1. Set the parking brake and shift to P (Park).
  2. Turn off the engine and remove the key.
  3. Block the wheels.
- Manual transmission:
  1. Set the parking brake, depress the clutch and place the gearshift in 1 (First).
  2. Turn off the engine and remove the key.
  3. Block the wheels.

#### Working with the engine on

- Automatic transmission:
  1. Set the parking brake and shift to P (Park).
  2. Block the wheels.
- Manual transmission:
  1. Set the parking brake, depress the clutch and place the gearshift in N (Neutral).
  2. Block the wheels.

**Note:** Do not start your engine with the air cleaner removed and do not remove it while the engine is running.



## Maintenance and Specifications

### OPENING THE HOOD

1. Inside the vehicle, pull the hood release handle located under the bottom of the instrument panel.

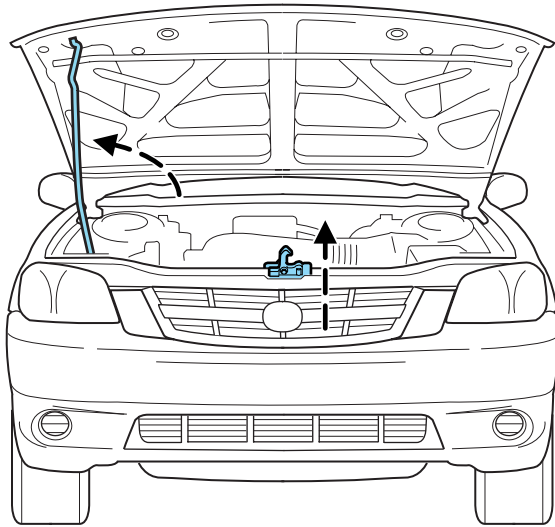
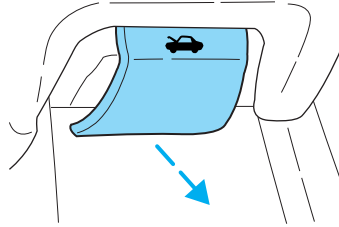

2. At the front of the vehicle, lift up on the auxiliary latch handle located in the center between the hood and the grille.
3. Lift the hood open and secure it with the prop rod.

## Maintenance and Specifications

### IDENTIFYING COMPONENTS IN THE ENGINE COMPARTMENT

#### 2.3L I4 engine

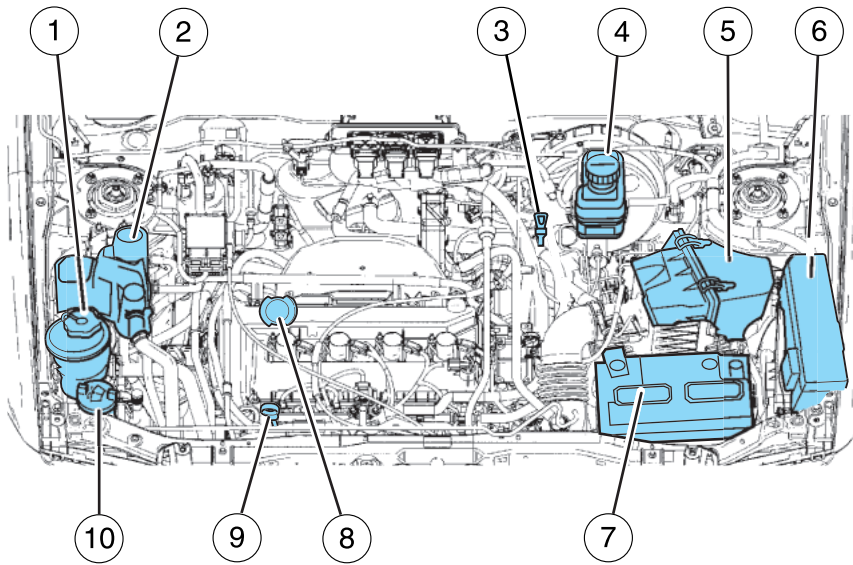

1. Power steering fluid reservoir
2. Engine coolant reservoir
3. Automatic transmission dipstick (if equipped)
4. Brake/Clutch fluid reservoir
5. Air filter assembly
6. Power distribution box
7. Battery
8. Engine oil filler cap
9. Engine oil dipstick
10. Windshield washer fluid reservoir

## Maintenance and Specifications

### 3.0L DOHC V6 engine

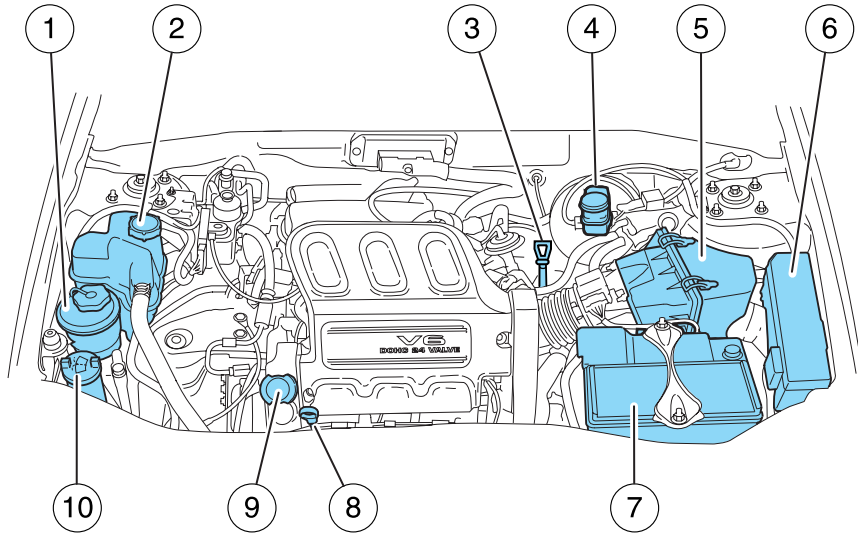

1. Power steering fluid reservoir
2. Engine coolant reservoir
3. Automatic transmission fluid dipstick
4. Brake fluid reservoir
5. Air filter assembly
6. Power distribution box
7. Battery
8. Engine oil dipstick
9. Engine oil filler cap
10. Windshield washer fluid reservoir

## Maintenance and Specifications

### WINDSHIELD WASHER FLUID

Check the washer fluid whenever you stop for fuel. The reservoir is highlighted with a  symbol.

Add fluid to fill the reservoir if the level is low. In very cold weather, do not fill the reservoir completely.

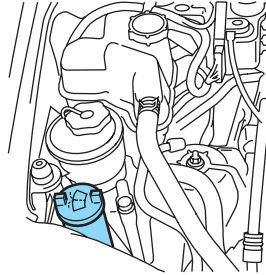

Only use a washer fluid that meets Mazda specifications. Refer to *Refill capacities* in this chapter.

**WARNING: If you operate your vehicle in temperatures below 40° F (4.5°C), use washer fluid with antifreeze protection. Failure to use washer fluid with antifreeze protection in cold weather could result in impaired windshield vision and increase the risk of injury or accident.**

**NOTE:** State or local regulations on volatile organic compounds may restrict the use of methanol, a common windshield washer antifreeze additive. Washer fluids containing non-methanol antifreeze agents should be used only if they provide cold weather protection without damaging the vehicle's paint finish, wiper blades or washer system.

**Note:** Do not put washer fluid in the engine coolant reservoir. Washer fluid placed in the cooling system may harm engine and cooling system components.

### Checking and adding washer fluid for the liftgate

Washer fluid for the liftgate is supplied by the same reservoir as the windshield.

### WINDSHIELD WIPER BLADES

Check the wiper blades for wear at least twice a year or when they seem less effective. Substances such as tree sap and some hot wax treatments used by commercial car washes reduce the effectiveness of wiper blades.

## Maintenance and Specifications

### Checking the wiper blades

If the wiper blades do not wipe properly, clean both the windshield and wiper blades using undiluted windshield wiper solution or a mild detergent. Rinse thoroughly with clean water. To avoid damaging the blades, do not use fuel, kerosene, paint thinner or other solvents.

### Changing the wiper blades

1. Pull the wiper arm away from the vehicle. Turn the blade at an angle from the wiper arm. Push the lock pin manually to release the blade and pull the wiper blade down toward the windshield to remove it from the arm.

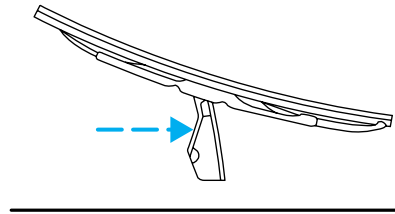

2. Attach the new wiper to the wiper arm and press it into place until a click is heard.

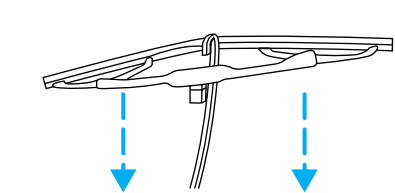

Replace wiper blades at least once per year for optimum performance.

Poor wiper quality can sometimes be improved by cleaning the wiper blades, refer to *Windows and wiper blades* in the *Cleaning* chapter.

To prolong the life of the wiper blades, it is highly recommended to scrape off the ice on the windshield before turning on the wipers. The layer of ice has many sharp edges and can damage the micro edge of the wiper rubber element.

### ENGINE OIL

#### Checking the engine oil

Refer to *service maintenance section* for the appropriate intervals for checking the engine oil.

1. Make sure the vehicle is on level ground.
2. Turn the engine off and wait a few minutes for the oil to drain into the oil pan.
3. Set the parking brake and ensure the gearshift is securely latched in P (Park) (automatic transmissions) or 1 (First) (manual transmissions).

## Maintenance and Specifications

4. Open the hood. Protect yourself from engine heat.
  5. Locate and carefully remove the engine oil level indicator (dipstick).
- 2.3L I4 engine

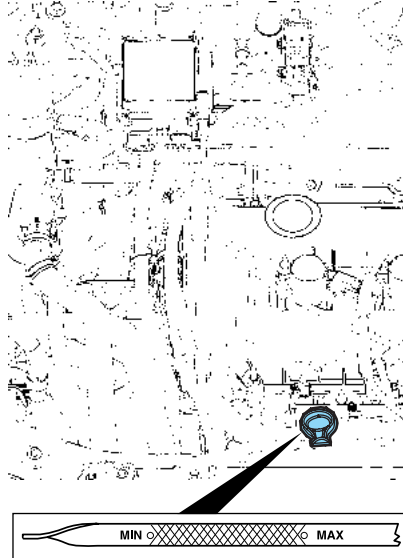

- 3.0L DOHC V6 Duratec engine

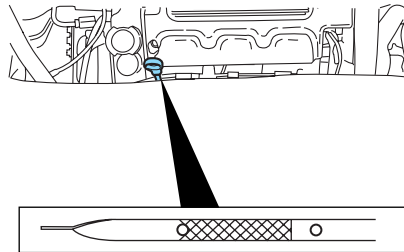

6. Wipe the indicator clean. Insert the indicator fully, then remove it again.
- If the oil level is within the MIN and MAX marks or the lower and upper holes, the oil level is acceptable. **DO NOT ADD OIL.**
  - If the oil level is below the MIN mark or the lower hole, engine **oil must be added** to raise the level within the normal operating range.

## Maintenance and Specifications

- 2.3L I4 engine

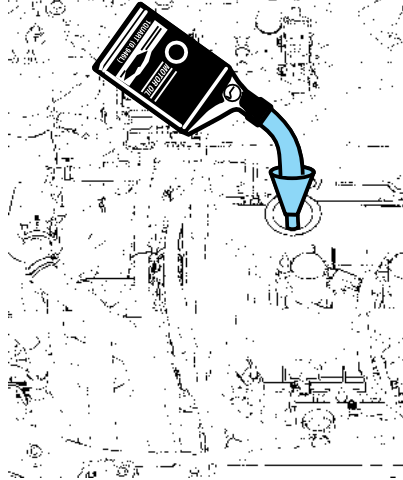

- 3.0L DOHC V6 Duratec engine

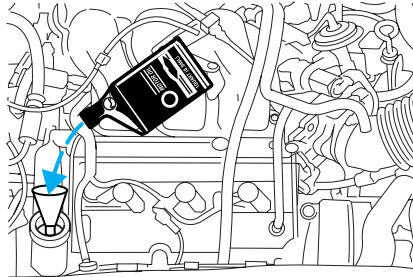

- If required, add engine oil to the engine. Refer to *Adding engine oil* in this chapter.
  - **Do not overfill the engine with oil. Oil levels above the MAX mark or upper hole may cause engine damage.** If the engine is overfilled, some oil must be removed from the engine by a qualified service technician.
7. Put the indicator back in and ensure it is fully seated.

## Maintenance and Specifications

### Adding engine oil

1. Check the engine oil. For instructions, refer to *Checking the engine oil* in this chapter.
2. If the engine oil level is not within the normal range, add only certified engine oil of the recommended viscosity. Remove the engine oil filler cap and use a funnel to pour the engine oil into the opening.
3. Recheck the engine oil level. Make sure the oil level is not above the MAX or FULL mark on the engine oil level indicator (dipstick).
4. Install the indicator and ensure it is fully seated.
5. Fully install the engine oil filler cap by turning the filler cap clockwise 1/4 of a turn until it is seated.

**To avoid possible oil loss, DO NOT operate the vehicle with the engine oil level indicator and/or the engine oil filler cap removed.**

### Engine oil and filter recommendations

#### ***SAE 5W-20 engine oil is recommended***

Look for this certification trademark.



Use SAE 5W-20 motor oil certified for gasoline engines by the American Petroleum Institute (API). An oil with this trademark symbol conforms to the current engine and emission system protection standards and fuel economy requirements of the International Lubricant Standardization and Approval Committee (ILSAC), comprised of U.S. and Japanese automobile manufacturers.

Motor oil displaying the API certification trademark will meet all requirements for your vehicle's engine.

232



## Maintenance and Specifications

Do not use supplemental engine oil additives, oil treatments or engine treatments. They are unnecessary and could, under certain conditions, lead to engine damage which is not covered by your warranty.

Change your engine oil and filter according to the appropriate schedule listed in the *service maintenance section*.

Mazda production and replacement oil filters are designed for added engine protection and long life. If a replacement oil filter is used that does not meet Mazda material and design specifications, start-up engine noises or knock may be experienced.

It is recommended you use the appropriate Genuine Mazda oil filter (or another brand meeting Mazda specifications) for your engine application.

### BATTERY

Your vehicle is equipped with a Mazda maintenance-free battery which normally does not require additional water during its life of service.

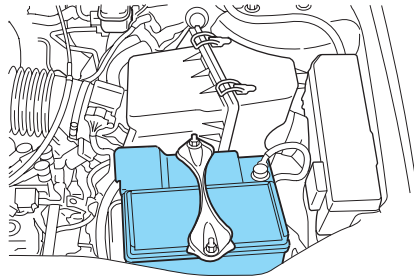

However, for severe usage or in high temperature climates, check the battery electrolyte level. Refer to the *Scheduled Maintenance* section for the service interval schedules.

**Keep the electrolyte level in each cell up to the “level indicator”. Do not overfill the battery cells.**

If the electrolyte level in the battery is low, you can add plain tap water to the battery, as long as you do not use hard water (water with a high mineral or alkali content). If possible, however, try to only fill the battery cells with distilled water. If the battery needs water often, have the charging system checked.

**If your battery has a cover/shield, make sure it is reinstalled after the battery has been cleaned or replaced.**

For longer, trouble-free operation, keep the top of the battery clean and dry. Also, make certain the battery cables are always tightly fastened to the battery terminals.

## Maintenance and Specifications

If you see any corrosion on the battery or terminals, remove the cables from the terminals and clean with a wire brush. You can neutralize the acid with a solution of baking soda and water.

**Note: Electrical or electronic accessories or components added to the vehicle by the dealer or the owner may adversely affect battery performance and durability.**

**WARNING: Batteries normally produce explosive gases which can cause personal injury. Therefore, do not allow flames, sparks or lighted substances to come near the battery. When working near the battery, always shield your face and protect your eyes. Always provide proper ventilation.**

**WARNING: When lifting a plastic-cased battery, excessive pressure on the end walls could cause acid to flow through the vent caps, resulting in personal injury and/or damage to the vehicle or battery. Lift the battery with a battery carrier or with your hands on opposite corners.**

**WARNING: Keep batteries out of reach of children. Batteries contain sulfuric acid. Avoid contact with skin, eyes or clothing. Shield your eyes when working near the battery to protect against possible splashing of acid solution. In case of acid contact with skin or eyes, flush immediately with water for a minimum of 15 minutes and get prompt medical attention. If acid is swallowed, call a physician immediately.**

**WARNING: Battery posts, terminals and related accessories contain lead and lead compounds. Wash hands after handling.**

Because your vehicle's engine is electronically controlled by a computer, some control conditions are maintained by power from the battery. When the battery is disconnected or a new battery is installed, the engine must relearn its idle and fuel trim strategy for optimum driveability and performance. To begin this process:

1. With the vehicle at a complete stop, set the parking brake.
2. Put the gearshift in P (Park) (automatic transmission) or the neutral position (manual transmission), turn off all accessories and start the engine.

## Maintenance and Specifications

3. Run the engine until it reaches normal operating temperature.
4. Allow the engine to idle for at least one minute.
5. Turn the A/C on and allow the engine to idle for at least one minute.
6. Drive the vehicle to complete the relearning process.

### NOTE:

- The vehicle may need to be driven to relearn the idle and fuel trim strategy.
- **If you do not allow the engine to relearn its idle trim, the idle quality of your vehicle may be adversely affected until the idle trim is eventually relearned.**

When the battery is disconnected or a new battery installed, the transmission must relearn its adaptive strategy. As a result of this, the transmission may shift firmly. This operation is considered normal and will not affect function or durability of the transmission. Over time the adaptive learning process will fully update transmission operation to its optimum shift feel.

If the battery has been disconnected or a new battery has been installed, the clock and the preset radio stations must be reset once the battery is reconnected.

- Always dispose of automotive batteries in a responsible manner. Follow your local authorized standards for disposal. Call your local authorized recycling center to find out more about recycling automotive batteries.

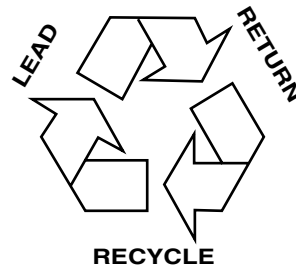

## ENGINE COOLANT

### Checking engine coolant

The concentration and level of engine coolant should be checked at the mileage intervals listed in the *Scheduled Maintenance* section. The coolant concentration should be maintained at 50/50 coolant and water, which equates to a freeze point of  $-34^{\circ}\text{F}$  ( $-36^{\circ}\text{C}$ ). Coolant concentration testing is possible with a hydrometer or antifreeze tester (such as the Rotunda Battery and Antifreeze Tester, 014-R1060). The level of coolant

## Maintenance and Specifications

should be maintained at the “FULL COLD” level or within the “COLD FILL RANGE” in the coolant reservoir. If the level falls below, add coolant per the instructions in the *Adding engine coolant* section.

Your vehicle was factory-filled with a 50/50 engine coolant and water concentration. If the concentration of coolant falls below 40% or above 60%, the engine parts could become damaged or not work properly. **A 50–50 mixture of coolant and water provides the following:**

- **freeze protection down to -34°F (-36°C).**
- **boiling protection up to 265°F (129°C).**
- **protection against rust and other forms of corrosion.**
- **an accurate temperature readout from the engine coolant gauge.**

When the engine is cold, check the level of the engine coolant in the reservoir.

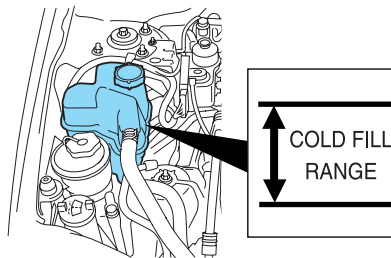

- The engine coolant should be at the “FULL COLD” level or within the “COLD FILL RANGE” as listed on the engine coolant reservoir (depending upon application).
- Refer to the *Scheduled Maintenance* section for service interval schedules.
- Be sure to read and understand *Precautions when servicing your vehicle* in this chapter.

If the engine coolant has not been checked at the recommended interval, the engine coolant reservoir may become low or empty. If the reservoir is low or empty, add engine coolant to the reservoir. Refer to *Adding engine coolant* in this chapter.

**WARNING: Automotive fluids are not interchangeable; do not use engine coolant, antifreeze or windshield washer fluid outside of its specified function and vehicle location.**

## Maintenance and Specifications

### Adding engine coolant

When adding coolant, make sure it is a 50/50 mixture of engine coolant and distilled water. Add the mixture to the coolant reservoir, **when the engine is cool**, until the appropriate fill level is obtained.

**WARNING: Do not add engine coolant when the engine is hot. Steam and scalding liquids released from a hot cooling system can burn you badly. Also, you can be burned if you spill coolant on hot engine parts.**

**WARNING: Do not put engine coolant in the windshield washer fluid container. If sprayed on the windshield, engine coolant could make it difficult to see through the windshield.**

The cooling system in your vehicle is filled with yellow-colored Mazda Premium Engine Coolant meeting Mazda Specifications.

**To maintain the integrity of the coolant and the cooling system and maintain the warranty on the cooling system:**

- **Add Mazda Premium Engine Coolant.**
- **Do not mix** different colors or types of coolant. Verify the type of coolant in your vehicle. Make sure the correct coolant is used.
- **Do not add/mix an orange-colored, extended life coolant such as Mazda Specialty Orange Engine Coolant, meeting Mazda specifications with the factory-filled coolant.** Mixing Mazda Specialty Orange Engine Coolant or any orange-colored extended life product with your factory filled coolant can result in degraded corrosion protection.
- A large amount of water without engine coolant may be added, in case of emergency, to reach a vehicle service location. In this instance, the cooling system must be drained and refilled with a 50/50 mixture of engine coolant and distilled water as soon as possible. Water alone (without engine coolant) can cause engine damage from corrosion, overheating or freezing.
- **Do not use alcohol, methanol or brine or any engine coolants mixed with alcohol or methanol antifreeze (coolant).** Alcohol and other liquids can cause engine damage from overheating or freezing.
- **Do not add extra inhibitors or additives to the coolant.** These can be harmful and compromise the corrosion protection of the engine coolant.

## Maintenance and Specifications

For vehicles with overflow coolant systems with a non-pressurized cap on the coolant recovery system, add coolant to the coolant recovery reservoir when the engine is cool. Add the proper mixture of coolant and water to the “FULL COLD” level. For all other vehicles, which have a coolant degas system with a pressurized cap, or if it is necessary to remove the coolant pressure relief cap on the radiator of a vehicle with an overflow system, follow these steps to add engine coolant.

**WARNING: To reduce the risk of personal injury, make sure the engine is cool before unscrewing the coolant pressure relief cap. The cooling system is under pressure; steam and hot liquid can come out forcefully when the cap is loosened slightly.**

1. Before you begin, turn the engine off and let it cool.
2. When the engine is cool, wrap a thick cloth around the coolant pressure relief cap on the coolant reservoir (an opaque plastic bottle). Slowly turn cap counterclockwise (left) until pressure begins to release.
3. Step back while the pressure releases.
4. When you are sure that all the pressure has been released, use the cloth to turn it counterclockwise and remove the cap.
5. Fill the coolant reservoir slowly with the proper coolant mixture (see above), to within the “COLD FILL RANGE” or the “FULL COLD” level on the reservoir. If you removed the radiator cap in an overflow system, fill the radiator until the coolant is visible and radiator is almost full.
6. Replace the cap. Turn until tightly installed. (Cap must be tightly installed to prevent coolant loss.)

After any coolant has been added, run the engine for a few minutes to mix the coolant. Check the coolant concentration. Make sure the engine is off and cool before removing the coolant pressure relief cap (see preceding steps on cap removal). Check the concentration per the *Checking engine coolant* section. If the concentration is not 50/50 (protection to -34°F/-36°C), drain some coolant and adjust the concentration. It may take several drains and additions to obtain a 50/50 coolant concentration.

Whenever coolant has been added, the coolant level in the coolant reservoir should be checked the next few times you drive the vehicle. If necessary, add enough 50/50 concentration of engine coolant and distilled water to bring the liquid level to the proper level.

## Maintenance and Specifications

If you have to add more than 1.0 quart (1.0 liter) of engine coolant per month, have your dealer check the engine cooling system. Your cooling system may have a leak. Operating an engine with a low level of coolant can result in engine overheating and possible engine damage).

### Recycled engine coolant

**Not all coolant recycling processes produce coolant which meets Mazda recommended coolants. Use of a recycled engine coolant which does not meet the Mazda recommended coolant, may harm engine and cooling system components.**



Always dispose of used automotive fluids in a responsible manner. Follow your community's regulations and standards for recycling and disposing of automotive fluids.

### Coolant refill capacity

To find out how much fluid your vehicle's cooling system can hold, refer to *Refill capacities* in this section.

Fill your engine coolant reservoir as outlined in *Adding engine coolant* in this section.

### Severe climates

If you drive in extremely cold climates (less than  $-34^{\circ}\text{ F}$  [ $-36^{\circ}\text{ C}$  ]):

- **It may be necessary to increase the coolant concentration above 50%.**
- **NEVER increase the coolant concentration above 60%.**
- **Increased engine coolant concentrations above 60% will decrease the overheat protection characteristics of the engine coolant and may cause engine damage.**
- **Refer to the chart on the coolant container to ensure the coolant concentration in your vehicle will provide adequate freeze protection at the temperatures in which you drive in the winter months.**

If you drive in extremely hot climates:

- **It is still necessary to maintain the coolant concentration above 40%.**
- **NEVER decrease the coolant concentration below 40%.**

## Maintenance and Specifications

- **Decreased engine coolant concentrations below 40% will decrease the corrosion protection characteristics of the engine coolant and may cause engine damage.**
- **Decreased engine coolant concentrations below 40% will decrease the freeze protection characteristics of the engine coolant and may cause engine damage.**
- **Refer to the chart on the coolant container to ensure the coolant concentration in your vehicle will provide adequate protection at the temperatures in which you drive.**

Vehicles driven year-round in non-extreme climates should use a 50/50 mixture of engine coolant and distilled water for optimum cooling system and engine protection.

### **What you should know about fail-safe cooling (2.3L I4 engine only)**

If the engine coolant supply is depleted, this feature allows the vehicle to be driven temporarily before incremental component damage is incurred. The “fail-safe” distance depends on ambient temperatures, vehicle load and terrain.

#### ***How fail-safe cooling works***

If the engine begins to overheat:

- The engine coolant temperature gauge will move to the red (hot) area.
- The  indicator light will illuminate.

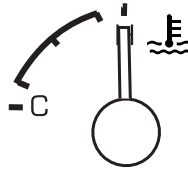

If the engine reaches a preset over-temperature condition, the engine will automatically switch to alternating cylinder operation. Each disabled cylinder acts as an air pump and cools the engine.

When this occurs the vehicle will still operate. However:

- The engine power will be limited.
- The air conditioning system will be disabled.

Continued operation will increase the engine temperature and the engine will completely shut down, causing steering and braking effort to increase.

Once the engine temperature cools, the engine can be re-started. Take your vehicle to a service facility as soon as possible to minimize engine damage.



## Maintenance and Specifications

### ***When fail-safe mode is activated***

You have limited engine power when in the fail-safe mode, so drive the vehicle with caution. The vehicle will not be able to maintain high-speed operation and the engine will run rough. Remember that the engine is capable of completely shutting down automatically to prevent engine damage, therefore:

1. Pull off the road as soon as safely possible and turn off the engine.
2. Arrange for the vehicle to be taken to a service facility.
3. If this is not possible, wait a short period for the engine to cool.
4. Check the coolant level and replenish if low.

**WARNING: Never remove the coolant reservoir cap while the engine is running or hot.**

5. Re-start the engine and take your vehicle to a service facility.

**Driving the vehicle without repairing the engine problem increases the chance of engine damage. Take your vehicle to a service facility as soon as possible.**

### **FUEL FILTER**

For fuel filter replacement, see your authorized Mazda dealership. Refer to *service maintenance section* for the appropriate intervals for changing the fuel filter.

**Replace the fuel filter with an authorized Mazda part. The customer warranty may be void for any damage to the fuel system if an authorized Mazda fuel filter is not used.**

### **WHAT YOU SHOULD KNOW ABOUT AUTOMOTIVE FUELS**

#### **Important safety precautions**

**WARNING: Do not overfill the fuel tank. The pressure in an overfilled tank may cause leakage and lead to fuel spray and fire.**

**WARNING: The fuel system may be under pressure. If the fuel filler cap is venting vapor or if you hear a hissing sound, wait until it stops before completely removing the fuel filler cap. Otherwise, fuel may spray out and injure you or others.**

## Maintenance and Specifications

**WARNING:** If you do not use the proper fuel filler cap, excessive pressure or vacuum in the fuel tank may damage the fuel system or cause the fuel cap to disengage in a collision, which may result in possible personal injury.

**WARNING:** Automotive fuels can cause serious injury or death if misused or mishandled.

**WARNING:** Gasoline may contain benzene, which is a cancer-causing agent.

Observe the following guidelines when handling automotive fuel:

**WARNING:** Automotive fuels can be harmful or fatal if swallowed. Fuel such as gasoline is highly toxic and if swallowed can cause death or permanent injury. If fuel is swallowed, call a physician immediately, even if no symptoms are immediately apparent. The toxic effects of fuel may not be visible for hours.



- Extinguish all smoking materials and any open flames before fueling your vehicle.
- Always turn off the vehicle before fueling.
- Avoid inhaling fuel vapors. Inhaling too much fuel vapor of any kind can lead to eye and respiratory tract irritation. In severe cases, excessive or prolonged breathing of fuel vapor can cause serious illness and permanent injury.
- Avoid getting fuel liquid in your eyes. If fuel is splashed in the eyes, remove contact lenses (if worn), flush with water for 15 minutes and seek medical attention. Failure to seek proper medical attention could lead to permanent injury.

242

## Maintenance and Specifications

- Fuels can also be harmful if absorbed through the skin. If fuel is splashed on the skin and/or clothing, promptly remove contaminated clothing and wash skin thoroughly with soap and water. Repeated or prolonged skin contact with fuel liquid or vapor causes skin irritation.
- Be particularly careful if you are taking “Antabuse” or other forms of disulfiram for the treatment of alcoholism. Breathing gasoline vapors, or skin contact could cause an adverse reaction. In sensitive individuals, serious personal injury or sickness may result. If fuel is splashed on the skin, promptly wash skin thoroughly with soap and water. Consult a physician immediately if you experience an adverse reaction.
- The Gasoline Distributors, who have converted many stations to self-service pumps are suggesting an increase of fires caused by static during refueling, particularly with women. They suggest you not climb back into your car during refuel as there is a chance you will build up a new electrical charge and not discharge it by touching anything metal before you grab the filler nozzle.

**WARNING: When refueling always shut the engine off and never allow sparks or open flames near the filler neck. Never smoke while refueling. Fuel vapor is extremely hazardous under certain conditions. Care should be taken to avoid inhaling excess fumes.**

**WARNING: The flow of fuel through a fuel pump nozzle can produce static electricity, which can cause a fire if fuel is pumped into an ungrounded fuel container. Be very careful to put the container on the ground before adding fuel to it.**

Use the following guidelines to avoid static build-up when filling an ungrounded fuel container:

- Place approved fuel container on the ground.
- DO NOT fill a fuel container while it is in the vehicle (including the cargo area).
- Keep the fuel pump nozzle in contact with the fuel container while filling.
- DO NOT use a device that would hold the fuel pump handle in the fill position.

## Maintenance and Specifications

### Fuel Filler Cap

Your fuel tank filler cap has an indexed design with a 1/4 turn on/off feature.

When fueling your vehicle:

1. Turn the engine off.
2. Carefully turn the filler cap counterclockwise 1/4 of a turn to unscrew the cap.
3. Pull to remove the cap from the fuel filler pipe.
4. Reinstall the cap on the filler pipe and turn it clockwise until at least one click is heard.

After refueling, if the “CHECK FUEL CAP” indicator comes on and stays on when you start the engine, the fuel filler cap may not be properly installed. Turn off the engine, remove the fuel filler cap, align the cap properly and reinstall it securely. The “CHECK FUEL CAP” indicator should turn off after three driving cycles with the fuel filler cap properly installed. A driving cycle consists of a cold engine start-up followed by mixed city/highway driving.

**If you must replace the fuel filler cap, replace it with a fuel filler cap that is designed for your vehicle. The customer warranty may be void for any damage to the fuel tank or fuel system if the correct genuine Mazda fuel filler cap is not used.**

**WARNING: The fuel system may be under pressure. Remove fuel filler cap slowly. Otherwise, fuel may spray out and injure you or others.**

**WARNING: If you do not use the proper fuel filler cap, excessive vacuum in the fuel tank may damage the fuel system or cause the fuel cap to disengage in a collision, which may result in possible personal injury.**

## Maintenance and Specifications

### Choosing the right fuel

- Use only UNLEADED FUEL. The use of leaded fuel is prohibited by law and could damage your vehicle.
- Your vehicle was not designed to use fuel or fuel additives with metallic compounds, including manganese-based additives. Studies indicate that these additives can cause your vehicle's emission control system to deteriorate more rapidly. In Canada, premium grade fuel generally contains more metallic additives than regular fuel. We recommend using regular grade fuel. In Canada, many fuels contain metallic additives, but fuels free of such additives may be available; check with your local fuel dealer.
- Do not use fuel containing methanol. It can damage critical fuel system components.
- Repairs to correct the effects of using a fuel for which your vehicle was not designed may not be covered by your warranty.

### Octane recommendations

Your vehicle is designed to use "Regular" unleaded gasoline with pump (R+M)/2 octane rating of 87.

We do not recommend the use of gasolines labeled as "Regular" that are sold with octane ratings of 86 or lower in high altitude areas.

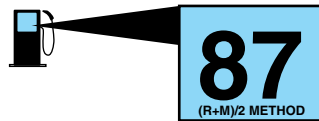

**NOTE:** Do not be concerned if your engine sometimes knocks lightly. However, if it knocks heavily under most driving conditions while you are using fuel with the recommended octane rating, see your authorized Mazda dealer to prevent any engine damage.

### Fuel quality

**NOTE:** If you are experiencing starting, rough idle or hesitation driveability problems during a cold start, try a different brand of "Regular" unleaded gasoline. "Premium" unleaded gasoline is not recommended (particularly in the United States) because it may cause these problems to become more pronounced. If the problems persist, see your authorized Mazda dealer.

It should not be necessary to add any aftermarket products to your fuel tank if you continue to use high quality fuel of the recommended octane rating.

**Aftermarket products could cause damage to the fuel system. Repairs to correct the effects of using an aftermarket product in your fuel may not be covered by your warranty.**

## Maintenance and Specifications

Many of the world's automakers approved the World-wide Fuel Charter that recommends gasoline specifications to provide improved performance and emission control system protection for your vehicle. Gasolines that meet the World-wide Fuel Charter should be used when available. Ask your fuel supplier about gasolines that meet the World-wide Fuel Charter.

### Cleaner air

Mazda endorses the use of reformulated "cleaner-burning" gasolines to improve air quality.

### Running out of fuel

Avoid running out of fuel because this situation may have an adverse affect on powertrain components.

If you have run out of fuel:

- You may need to cycle the ignition from OFF to ON several times after refueling, to allow the fuel system to pump the fuel from the tank to the engine.
- The  indicator may come on. For more information on the "Check Engine" indicator, refer to the *Instrument Cluster* chapter.

## ESSENTIALS OF GOOD FUEL ECONOMY

### Measuring techniques

Your best source of information about actual fuel economy is you, the driver. You must gather information as accurately and consistently as possible. Fuel expense, frequency of fillups or fuel gauge readings are NOT accurate as a measure of fuel economy. We do not recommend taking fuel economy measurements during the first 1,000 miles (1,600 km) of driving (engine break-in period). You will get a more accurate measurement after 2,000 miles-3,000 miles (3,000 km-5,000 km).

### Filling the tank

The advertised fuel capacity of the fuel tank on your vehicle is equal to the rated refill capacity of the fuel tank as listed in the *Refill capacities* section of this chapter.

The advertised capacity is the amount of the indicated capacity and the empty reserve combined. Indicated capacity is the difference in the amount of fuel in a full tank and a tank when the fuel gauge indicates empty. Empty reserve is the small amount of fuel remaining in the fuel tank after the fuel gauge indicates empty.

246

## Maintenance and Specifications

**The amount of usable fuel in the empty reserve varies and should not be relied upon to increase driving range. When refueling your vehicle after the fuel gauge indicates empty, you might not be able to refuel the full amount of the advertised capacity of the fuel tank due to the empty reserve still present in the tank.**

For consistent results when filling the fuel tank:

- Turn the engine/ignition switch to the off position prior to refueling, an error in the reading will result if the engine is left running.
- Use the same filling rate setting (low — medium — high) each time the tank is filled.
- Allow no more than two automatic click-offs when filling.
- Always use fuel with the recommended octane rating.
- Use a known quality gasoline, preferably a national brand.
- Use the same side of the same pump and have the vehicle facing the same direction each time you fill up.
- Have the vehicle loading and distribution the same every time.

Your results will be most accurate if your filling method is consistent.

### Calculating fuel economy

1. Fill the fuel tank completely and record the initial odometer reading (in miles or kilometers).
2. Each time you fill the tank, record the amount of fuel added (in gallons or liters).
3. After at least three to five tank fill-ups, fill the fuel tank and record the current odometer reading.
4. Subtract your initial odometer reading from the current odometer reading.
5. Follow one of the simple calculations in order to determine fuel economy:

Calculation 1: **Divide total miles traveled by total gallons used.**

Calculation 2: **Multiply liters used by 100, then divide by total kilometers traveled.**

Keep a record for at least one month and record the type of driving (city or highway). This will provide an accurate estimate of the vehicle's fuel economy under current driving conditions. Additionally, keeping records during summer and winter will show how temperature impacts fuel economy. In general, lower temperatures give lower fuel economy.

## Maintenance and Specifications

### Driving style — good driving and fuel economy habits

Give consideration to the lists that follow and you may be able to change a number of variables and improve your fuel economy.

#### **Habits**

- Smooth, moderate operation can yield up to 10% savings in fuel.
- Steady speeds without stopping will usually give the best fuel economy.
- Idling for long periods of time (greater than one minute) may waste fuel.
- Anticipate stopping; slowing down may eliminate the need to stop.
- Sudden or hard accelerations may reduce fuel economy.
- Slow down gradually.
- Driving at reasonable speeds (traveling at 55 mph [88 km/h] uses 15% less fuel than traveling at 65 mph [105 km/h]).
- Revving the engine before turning it off may reduce fuel economy.
- Using the air conditioner or defroster may reduce fuel economy.
- You may want to turn off the speed control in hilly terrain if unnecessary shifting between third and fourth gear occurs. Unnecessary shifting of this type could result in reduced fuel economy.
- Warming up a vehicle on cold mornings is not required and may reduce fuel economy.
- Resting your foot on the brake pedal while driving may reduce fuel economy.
- Combine errands and minimize stop-and-go driving.

#### **Maintenance**

- Keep tires properly inflated and use only recommended size.
- Operating a vehicle with the wheels out of alignment will reduce fuel economy.
- Use recommended engine oil. Refer to *Lubricant specifications* in this chapter.
- Perform all regularly scheduled maintenance items. Follow the recommended maintenance schedule and owner maintenance checks found in *service maintenance section*.



## Maintenance and Specifications

### Conditions

- Heavily loading a vehicle or towing a trailer may reduce fuel economy at any speed.
- Carrying unnecessary weight may reduce fuel economy (approximately 1 mpg [0.4 km/L] is lost for every 400 lb [180 kg] of weight carried).
- Adding certain accessories to your vehicle (for example bug deflectors, rollbars/light bars, running boards, ski/luggage racks) may reduce fuel economy.
- Using fuel blended with alcohol may lower fuel economy.
- Fuel economy may decrease with lower temperatures during the first 8–10 miles (12–16 km) of driving.
- Driving on flat terrain offers improved fuel economy as compared to driving on hilly terrain.
- Transmissions give their best fuel economy when operated in the top cruise gear and with steady pressure on the gas pedal.
- Close windows for high speed driving.

### EPA window sticker

Every new vehicle should have the EPA window sticker. Contact your dealer if the window sticker is not supplied with your vehicle. The EPA window sticker should be your guide for the fuel economy comparisons with other vehicles.

It is important to note the box in the lower left corner of the window sticker. These numbers represent the Range of MPG (L/100 km) expected on the vehicle under optimum conditions. Your fuel economy may vary depending upon the method of operation and conditions.

### EMISSION CONTROL SYSTEM

Your vehicle is equipped with various emission control components and a catalytic converter which will enable your vehicle to comply with applicable exhaust emission standards. To make sure that the catalytic converter and other emission control components continue to work properly:

- Use only the specified fuel listed.
- Avoid running out of fuel.
- Do not turn off the ignition while your vehicle is moving, especially at high speeds.

## Maintenance and Specifications

- Have the items listed in the *Scheduled Maintenance* section performed according to the specified schedule.

The scheduled maintenance items listed in the scheduled maintenance section are essential to the life and performance of your vehicle and to its emissions system.

If other than Mazda authorized parts are used for maintenance replacements or for service of components affecting emission control, such non-Mazda parts should be equivalent to genuine Mazda parts in performance and durability.

**WARNING: Do not park, idle, or drive your vehicle in dry grass or other dry ground cover. The emission system heats up the engine compartment and exhaust system, which can start a fire.**

Illumination of the  indicator, charging system warning light or the temperature warning light, fluid leaks, strange odors, smoke or loss of engine power, could indicate that the emission control system is not working properly.

**WARNING: Exhaust leaks may result in entry of harmful and potentially lethal fumes into the passenger compartment.**

Do not make any unauthorized changes to your vehicle or engine. By law, vehicle owners and anyone who manufactures, repairs, services, sells, leases, trades vehicles, or supervises a fleet of vehicles are not permitted to intentionally remove an emission control device or prevent it from working. Information about your vehicle's emission system is on the Vehicle Emission Control Information Decal located on or near the engine. This decal identifies engine displacement and gives some tune up specifications.

Please consult your "Warranty Information" for complete emission warranty information.

### On board diagnostics (OBD-II)

Your vehicle is equipped with a computer that monitors the engine's emission control system. This system is commonly known as the On Board Diagnostics System (OBD-II). This OBD-II system protects the environment by ensuring that your vehicle continues to meet government emission standards. The OBD-II system also assists the service technician in properly servicing your vehicle. When the *Check engine/Service engine soon* light illuminates, the OBD-II system has

250

## Maintenance and Specifications



detected a malfunction. Temporary malfunctions may cause your *Check engine/Service engine soon* light to illuminate. Examples are:

1. The vehicle has run out of fuel. (The engine may misfire or run poorly.)
2. Poor fuel quality or water in the fuel.
3. The fuel cap may not have been securely tightened. See *Fuel filler cap* in this chapter.

These temporary malfunctions can be corrected by filling the fuel tank with good quality fuel and/or properly tightening the fuel cap. After three driving cycles without these or any other temporary malfunctions present, the *Check engine/Service engine soon* light should turn off. (A driving cycle consists of a cold engine startup followed by mixed city/highway driving.) No additional vehicle service is required.

If the *Check engine/Service engine soon* light remains on, have your vehicle serviced at the first available opportunity.

### Readiness for Inspection/Maintenance (I/M) testing

In some localities, it may be a legal requirement to pass an I/M test of the on-board diagnostics system. If your  indicator is on, refer to the description in the *Warning lights and chimes* section of the *Instrument Cluster* chapter. Your vehicle may not pass the I/M test with the  indicator on.

If the vehicle's powertrain system or its battery has just been serviced, the on-board diagnostics system is reset to a "not ready for I/M test" condition. To ready the on-board diagnostics system for I/M testing, a minimum of 30 minutes of city and highway driving is necessary as described below:

- First, at least 10 minutes of driving on an expressway or highway.
- Next, at least 20 minutes driving in stop-and-go, city-type traffic with at least four idle periods.

Allow the vehicle to sit for at least eight hours without starting the engine. Then, start the engine and complete the above driving cycle. The engine must warm up to its normal operating temperature. Once started, do not turn off the engine until the above driving cycle is complete.

## Maintenance and Specifications

### POWER STEERING FLUID

Check the power steering fluid. Refer to the *service maintenance section* for the service interval schedules. **If adding fluid is necessary, use only MERCON® ATF.**

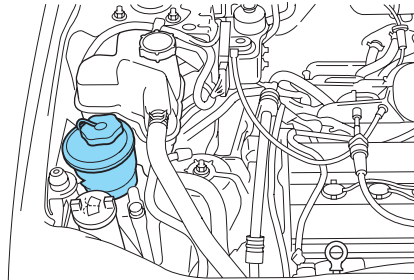

1. Start the engine and let it run until it reaches normal operating temperature (the engine coolant temperature gauge indicator will be near the center of the normal area between H and C).
2. While the engine idles, turn the steering wheel left and right several times.
3. Turn the engine off.
4. Check the fluid level in the reservoir. It should be between the MIN and MAX lines. Do not add fluid if the level is in this range.

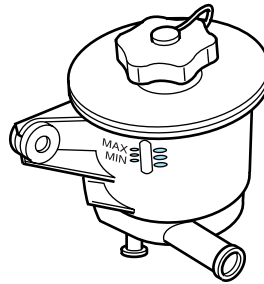

5. If the fluid is low, add fluid in small amounts, continuously checking the level until it reaches the range between the MIN and MAX lines. Be sure to put the cap back on the reservoir.

## Maintenance and Specifications

### BRAKE/CLUTCH (IF EQUIPPED) FLUID

Brake and clutch systems are supplied from the same reservoir.

The fluid level will drop slowly as the brakes wear, and will rise when the brake components are replaced. Fluid levels between the “MIN” and “MAX” lines are within the normal operating range, there is no need to add fluid. If the fluid levels are outside of the normal operating range, the performance of your brake/clutch (if equipped) system could be compromised, seek service from an authorized Mazda dealer immediately.

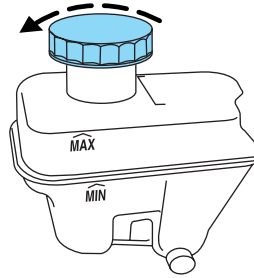

### TRANSMISSION FLUID

#### Checking automatic transmission fluid

Refer to your scheduled maintenance section for scheduled intervals for fluid checks and changes. Your transaxle does not consume fluid. However, the fluid level should be checked if the transaxle is not working properly, i.e., if the transaxle slips or shifts slowly or if you notice some sign of fluid leakage.

**Automatic transmission fluid expands when warmed. To obtain an accurate fluid check, drive the vehicle until it is warmed up (approximately 20 miles [30 km]). If your vehicle has been operated for an extended period at high speeds, in city traffic during hot weather or pulling a trailer, the vehicle should be turned off for about 30 minutes to allow fluid to cool before checking.**

1. Drive the vehicle 20 miles (30 km) or until it reaches normal operating temperature.
2. Park the vehicle on a level surface and engage the parking brake.
3. With the parking brake engaged and your foot on the brake pedal, start the engine and move the gearshift lever through all of the gear ranges. Allow sufficient time for each gear to engage.
4. Latch the gearshift lever in P (Park) and leave the engine running.
5. Remove the dipstick, wiping it clean with a clean, dry lint free rag. If necessary, refer to *Identifying components in the engine compartment* in this chapter for the location of the dipstick.

## Maintenance and Specifications

6. Install the dipstick making sure it is fully seated in the filler tube.
7. Remove the dipstick and inspect the fluid level. The fluid should be in the crosshatch zone for normal operating temperature.

### Low fluid level

Do not drive the vehicle if the fluid level is at the bottom of the dipstick and the outside temperatures are above 50°F (10°C).

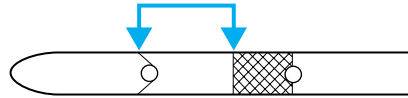

### Correct fluid level

The transmission fluid should be checked at normal operating temperatures 150°F-170°F (66°C-77°C) on a level surface. The normal operating temperature can be reached after approximately 20 miles (30 km) of driving.

The transmission fluid should be in the crosshatch zone if at normal operating temperature (150°F-170°F [66°C-77°C]).

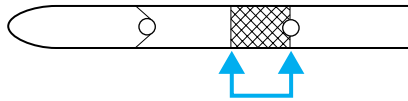

### High fluid level

**Fluid levels above the crosshatch zone may result in transaxle failure. An overfill condition of transmission fluid may cause shift and/or engagement concerns and/or possible damage.**

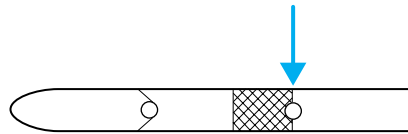

High fluid levels can be caused by an overheating condition.

### Adjusting automatic transmission fluid levels

Before adding any fluid, make sure the correct type is used. The type of fluid used is normally indicated on the dipstick and also in the *Lubricant specifications* section in this chapter.

**Use of a non-approved automatic transmission fluid may cause internal transaxle component damage.**

If necessary, add fluid in 1/2 pint (250 mL) increments through the filler tube until the level is correct.

## Maintenance and Specifications

If an overfill occurs, excess fluid should be removed by a qualified technician.

**An overfill condition of transmission fluid may cause shift and/or engagement concerns and/or possible damage.**

Do not use supplemental transmission fluid additives, treatments or cleaning agents. The use of these materials may affect transmission operation and result in damage to internal transmission components.

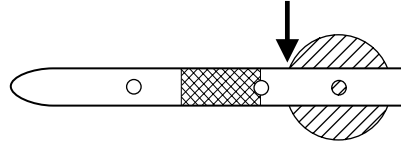

### Checking and adding manual transmission fluid

1. Clean the filler plug.
2. Remove the filler plug and inspect the fluid level.
3. Fluid level should be at bottom of the opening.

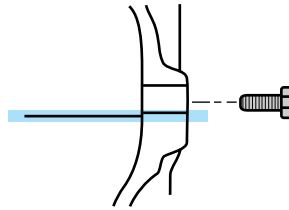

4. Add enough fluid through the filler opening so that the fluid level is at the bottom of the opening.
5. Install and tighten the fill plug securely.

Use only fluid that meets Mazda specifications. Refer to the *Refill capacities* in this chapter.

### AIR FILTER

Refer to *scheduled maintenance* for the appropriate intervals for changing the air filter element.

When changing the air filter element, only use a genuine Mazda air filter element.

**WARNING: Don't drive without an air filter. This could result in excessive engine wear.**

1. Loosen the clamp that secures the air inlet tube to the engine air filter cover and disconnect the tube from the cover (for V6 only).

## Maintenance and Specifications

2. Release the clamps that secure the air filter housing cover.
3. Carefully separate the two halves of the air filter housing.

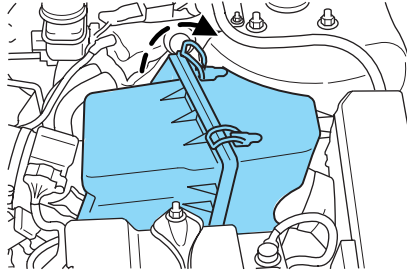

4. Remove the air filter element from the air filter housing.
5. Wipe the air filter housing and cover clean to remove any dirt or debris and to ensure good sealing.
6. Install a new air filter element.

**Be careful not to crimp the filter element edges between the air filter housing and cover. This could cause filter damage and allow unfiltered air to enter the engine if not properly seated.**

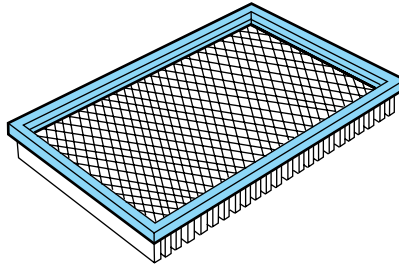

7. Replace the air filter housing cover and secure the clamps.
8. Replace the air inlet tube and secure the clamp.

**Note:** Failure to use the correct air filter element may result in severe engine damage. The customer warranty may be voided for any damage to the engine if the correct air filter element is not used.



## Maintenance and Specifications

### REFILL CAPACITIES

Fluid	Classification	Application	Capacity
Brake fluid	High Performance DOT 3 Motor Vehicle Brake Fluid	All	Fill to line on reservoir
Engine oil (including filter change)	SAE 5W-20	2.3L I4 engine	4.5 quarts (4.25L)
		3.0L V6 engine	6.0 quarts (5.7L)
Fuel tank	N/A	2.3L I4 engine	16.5 gallons (62L)
		3.0L V6 engine	16.5 gallons (62L)
Power steering fluid	MERCON®	All	Fill to line on reservoir
Transmission fluid <sup>1</sup>	API service GL-4, SAE 75W-90	Manual transaxle (2WD)	2.4 quarts (2.3L) <sup>2</sup>
		Manual transaxle (4WD)	2.5 quarts (2.4L) <sup>2</sup>
	MERCON® ATF	2.3L / 3.0L engine with Automatic transaxle and oil cooler	10.2 quarts (9.6L) <sup>3</sup>
Transfer Case	API service GL-5, SAE 75W-140 Synthetic Lubricant	4WD (Automatic)	12 ounces (0.35L)
	API service GL-5, SAE 80W-90	4WD (Manual)	12 ounces (0.35L)

## Maintenance and Specifications

Fluid	Classification	Application	Capacity
Engine coolant <sup>4</sup>	Mazda yellow-colored Premium Engine Coolant	2.3L I4 engine with manual transaxle	5.3 quarts (5.0L)
		2.3L I4 engine with automatic transaxle	6.3 quarts (6.0L)
		3.0L V6 engine with automatic transaxle	10.6 quarts (10.0L )
Rear axle lubricant	API service GL-5, SAE 80W-90 Premium Rear Axle Lubricant	4WD	2.96 pints (1.4L) <sup>5</sup>
Windshield washer fluid	N/A	All	4.8 quarts (4.5L)

<sup>1</sup>Ensure the correct automatic transmission fluid is used. Transmission fluid requirements are indicated on the dipstick or on the dipstick handle. MERCON® and MERCON® V are not interchangeable. DO NOT mix MERCON® and MERCON® V. Refer to your scheduled maintenance section to determine the correct service interval.

<sup>2</sup>Service refill capacity is determined by filling the transmission to the bottom of the filler hole with the vehicle on a level surface.

<sup>3</sup>Indicates only approximate dry-fill capacity. Some applications may vary based on cooler size and if equipped with an in-tank cooler. The amount of transmission fluid and fluid level should be set by the indication on the dipstick's normal operating range.

<sup>4</sup>Add the coolant type originally equipped in your vehicle. DO NOT MIX different colors or types of coolant. DO NOT USE Extended Life Engine Coolant (orange in color). Refer to *Adding engine coolant* in this chapter.

<sup>5</sup>Fill from 1/4 inch to 9/16 inch (6 mm to 14 mm) below bottom of fill hole.

For further information on your lubrication specifications, see your authorized Mazda dealer.

## Maintenance and Specifications

### ENGINE SPECIFICATIONS

Engine	2.3L I4 engine	3.0L DOHC V6 engine
Cubic inches	140	183
Required fuel	87 octane	87 octane
Firing order	1-3-4-2	1-4-2-5-3-6
Ignition system	Coil on plug	Coil on plug
Spark plug gap	0.049–0.053 inch (1.25–1.35mm)	0.052–0.056 inch (1.32–1.42mm)
Compression ratio	9.7:1	10.0:1

### VEHICLE DIMENSIONS

Dimensions	4 Door - inches (mm)
(1) Vehicle height w/o roof rack / with roof rack	67.7 (1,720)/70.0 (1,779)
(2) Front track / rear	61.3 (1,557)/60.9 (1,548)
(3) Overall width (body)	72.0 (1,828)
(4) Wheelbase	103.2 (2,621)
(5) Overall length w/o trailer hitch / with trailer hitch	174.4 (4,429)/174.7 (4,438)

## Maintenance and Specifications

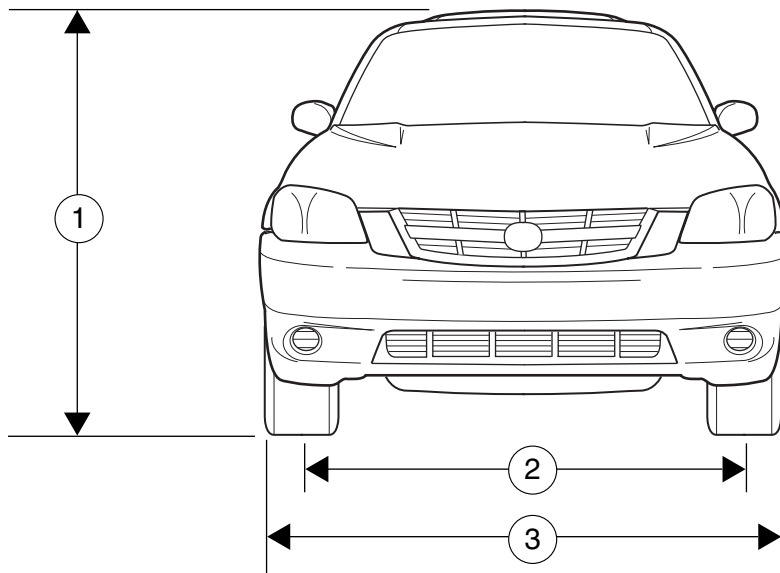

## Maintenance and Specifications

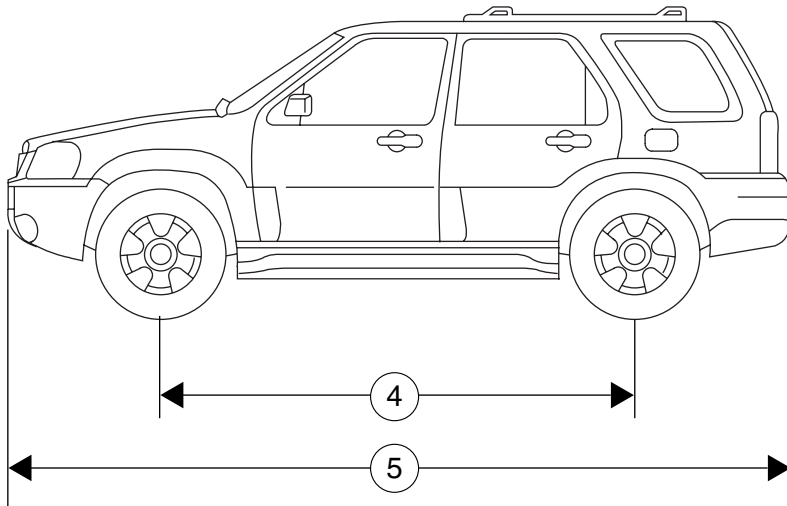

### IDENTIFYING YOUR VEHICLE

#### Safety Compliance Certification Label

The National Highway Traffic Safety Administration Regulations require that a Safety Compliance Certification Label be affixed to a vehicle and prescribe where the Safety Compliance Certification Label may be located. The Safety Compliance Certification Label is located on the structure by the trailing edge of the driver's door or the edge of the driver's door.

## Maintenance and Specifications

### Vehicle identification number (VIN)

The vehicle identification number is attached to a metal tag and is located on the driver side instrument panel. (Please note that in the graphic XXXX is representative of your vehicle identification number.)

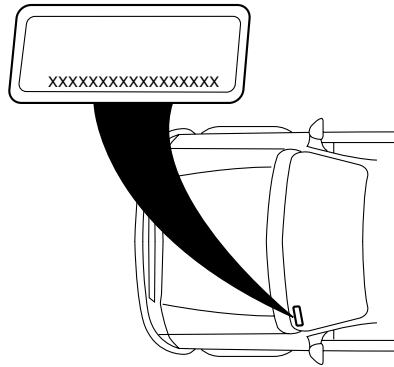

The Vehicle Identification Number (VIN) contains the following information:

1. World manufacturer identifier
2. Brake type and Gross Vehicle Weight Rating (GVWR)
3. Vehicle line, series, body type
4. Engine type
5. Check digit
6. Model year
7. Assembly plant
8. Production sequence number

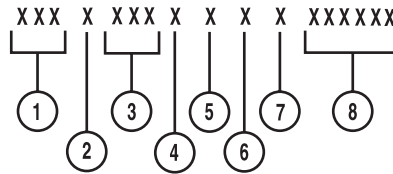

## Maintenance and Specifications

### TRANSMISSION/TRANSAXLE CODE DESIGNATIONS

You can find a transmission/transaxle code on the Safety Compliance Certification Label. The following table tells you which transmission or transaxle each code represents.

MFD. BY FORD MOTOR CO. IN U.S.A.							
DATE: XX/XX	GVWR: XXXXXLB/ XXXXXKG						
FRONT GAWR: XXXXL	REAR GAWR: XXXXLB						
XXXXKG	WITH	XXXXKG	WITH				
XXXX/XXXXXXXX	TIRES	XXXX/XXXXXXXX	TIRES				
XXXX.XX	RIMS	XXXX.XX	RIMS				
AT XXX kPa/XX	PSI COLD	AT XXX kPa/XX	PSI COLD				
THIS VEHICLE CONFORMS TO ALL APPLICABLE FEDERAL MOTOR VEHICLE SAFETY AND THEFT PREVENTION STANDARDS IN EFFECT ON THE DATE OF MANUFACTURE SHOWN ABOVE.							
VIN: XXXXXXXXXXXXXXXXX	XXXXX			XXXXX			
TYPE: XXX							
							
EXT PNT: XX	RC: XX	DSO:					
WB ' BRK ' INT TR ' TP/PS ' R ' AXLE ' TR ' SPR ' XXXXX							
XXX X XX X XX X XX X XX XXX							
XXXXXXXXXXXXX UTC V2USA-1520472-AA							



Code	Description
3	Five-speed manual
4	Four-speed automatic

## Accessories

### CELL PHONES

Use of cell phones and other devices by driver:

**WARNING:** Use of any electrical devices such as cell phones, computers, portable radios, vehicle navigation or other devices by the driver while the vehicle is moving is dangerous. Dialing a number on a cell phone while driving also ties-up the driver's hands. Use of these devices will cause the driver to be distracted and could lead to a serious accident. If a passenger is unable to use the device, pull off the right-of-way to a safe area before use. If use of a cell phone is necessary despite this warning, use a hands-free system to at least allow the hands free to drive the vehicle. Never use a cell phone or other electrical device while the vehicle is moving and, instead, concentrate on the full-time job of driving. In addition, the gasoline distributors are warning against using cell phones during refueling procedures, due to their increased concern about static electricity fires in the self-service pump environment.



## Index

### A

ABS (see Brakes) .....153  
Accessory delay .....48  
Air cleaner filter .....255, 257  
Air conditioning  
  manual heating and air  
  conditioning system .....30  
Airbag supplemental restraint  
system .....93, 100, 103  
  and child safety seats .....95  
  description .....93, 100, 103  
  disposal .....106  
  driver airbag .....95, 101, 104  
  indicator light .....100, 102, 106  
  operation .....95, 101, 104  
  passenger airbag .....95, 101, 104  
  side airbag .....100  
Ambulance packages .....7  
Antifreeze  
(see Engine coolant) .....235  
Anti-lock brake system  
(see Brakes) .....153–154  
Anti-theft system .....67  
  arming the system .....67  
  disarming a triggered system ..68  
Automatic transaxle  
  fluid, adding .....253  
  fluid, checking .....253  
Automatic transmission .....157  
  driving an automatic  
  overdrive .....159  
  fluid, refill capacities .....257  
Auxiliary power point .....46  
Axle  
  refill capacities .....257

### B

Battery .....233

  acid, treating emergencies .....233  
  jumping a disabled battery ....193  
  maintenance-free .....233  
  servicing .....233  
BeltMinder .....88  
Brakes .....153  
  anti-lock .....153–154  
  anti-lock brake system (ABS)  
  warning light .....154  
  fluid, checking and adding ....253  
  fluid, refill capacities .....257  
  fluid, specifications .....259  
  lubricant specifications .....259  
  parking .....154  
  shift interlock .....157  
Break-in period .....6  
Bulbs .....37

### C

Calculating load .....142  
Capacities for refilling fluids ....257  
Cargo area shade .....54  
Cell phone warning .....264  
Child safety restraints .....107  
  child safety belts .....107  
Child safety seats .....110  
  attaching with tether straps ..114  
Cleaning your vehicle  
  engine compartment .....212  
  instrument panel .....214  
  interior .....215  
  interior trim .....214  
  Mazda car care products .....216  
  plastic parts .....213  
  washing .....211  
  waxing .....211  
  wheels .....212  
  wiper blades .....214

## Index

Climate control (see Air conditioning or Heating) .....30

Clock adjust  
6-CD in dash .....24  
AM/FM/CD .....19

Clutch  
fluid .....253  
operation while driving .....162  
recommended shift speeds ....163

Console .....47  
overhead .....44

Controls  
power seat .....71

Coolant  
checking and adding .....235  
refill capacities .....239, 257  
specifications .....259

Cruise control .....50

Cruise control  
(see Speed control) .....50

Customer Assistance .....200–201,  
203

**D**

Daytime running lamps  
(see Lamps) .....33

Dipstick  
automatic transmission fluid ...253  
engine oil .....229

Door locks .....57

Driving under special  
conditions .....161, 167, 170  
sand .....168  
snow and ice .....171  
through water .....169, 172

## E

Emergencies, roadside  
jump-starting .....193

Emission control system .....249

Engine .....259  
cleaning .....212  
coolant .....235  
fail-safe cooling .....240  
idle speed control .....233  
lubrication specifications .....259  
refill capacities .....257  
service points .....226–227

Engine block heater .....152

Engine oil .....229  
checking and adding .....229  
dipstick .....229  
filter, specifications .....232  
recommendations .....232  
refill capacities .....257  
specifications .....259

Exhaust fumes .....151

## F

Fail safe cooling .....240

Fluid capacities .....257

Foglamps .....33

Four-Wheel Drive vehicles  
driving off road .....165–166  
indicator light .....165  
preparing to drive your  
vehicle .....156

Fuel .....241  
calculating fuel economy .....246  
cap .....244  
capacity .....257  
choosing the right fuel .....245

## Index

- comparisons with EPA fuel
- economy estimates .....249
- detergent in fuel .....246
- filling your vehicle with
- fuel .....241, 244, 246
- filter, specifications .....241
- improving fuel economy .....246
- octane rating .....245, 259
- quality .....245
- running out of fuel .....246
- safety information relating to
- automotive fuels .....241
- Fuses .....174–175
- G**
- Garage door opener .....44
- Gas cap (see Fuel cap) .....244
- Gas mileage
- (see Fuel economy) .....246
- Gauges .....17
- engine coolant temperature
- gauge .....19
- fuel gauge .....19
- odometer .....19
- tachometer .....19
- trip odometer .....19
- GAWR (Gross Axle Weight
- Rating)
- calculating .....142
- GVWR (Gross Vehicle Weight
- Rating)
- calculating .....142
- H**
- Hazard flashers .....173
- Head restraints .....69, 72
- Headlamps .....32
- aiming .....34
- bulb specifications .....37
- daytime running lights .....33
- flash to pass .....32
- high beam .....32
- replacing bulbs .....38
- turning on and off .....32
- Heating
- manual heating and air
- conditioning system .....30
- Hood .....225
- I**
- Ignition .....148, 259
- Infant seats
- (see Safety seats) .....110
- Inspection/maintenance (I/M)
- testing .....251
- Instrument panel
- cleaning .....214
- cluster .....12
- lighting up panel and
- interior .....34
- location of components .....12
- J**
- Jump-starting your vehicle .....193
- K**
- Keys
- positions of the ignition .....148
- L**
- Lamps
- bulb replacement
- specifications chart .....37
- cargo lamps .....34
- daytime running light .....33

## Index

- fog lamps .....33
- headlamps .....32
- headlamps, flash to pass .....32
- instrument panel, dimming ....34
- interior lamps .....36–37
- replacing bulbs .....37–38, 40–41
- Lane change indicator  
(see Turn signal) .....35
- Liftgate .....54
- Lights, warning and indicator ....12
  - anti-lock brakes (ABS) .....154
- Load limits .....135
- Loading instructions .....142
- Locks
  - childproof .....59
  - doors .....57
- Lubricant specifications .....259
- Lug nuts .....191
- Luggage rack .....55
- Lumbar support, seats .....71
- M**
- Manual transaxle .....162
  - fluid, checking and adding ....255
  - reverse .....163
- Manual transmission
  - fluid capacities .....257
- Mirrors .....45, 49
  - fold away .....49
  - heated .....49
  - side view mirrors (power) .....49
- Moon roof .....53
- Motorcraft parts .....241
- O**
- Octane rating .....245
- Oil (see Engine oil) .....229
- Overdrive .....158
- Overheating .....192
- P**
- Parking .....164
- Parking brake .....154
- Passenger Occupant  
Classification Sensor .....79
- Passive anti-theft system  
(PATS) .....64
- Power distribution box  
(see Fuses) .....178
- Power door locks .....57
- Power mirrors .....49
- Power point .....46
- Power Seats .....71
- Power steering .....155
  - fluid, checking and adding ....252
  - fluid, refill capacity .....257
  - fluid, specifications .....259
- Power Windows .....47
- Preparing to drive your  
vehicle .....156
- R**
- Rear window defroster .....31
- Relays .....174
- Remote entry system
  - illuminated entry .....63–64
- Roof rack .....55
- S**
- Safety Belt Maintenance .....87

## Index

- Safety belts (see Safety restraints) .....77, 81–85
- Safety Canopy .....101
- Safety restraints .....77, 81–85  
belt minder .....88  
extension assembly .....87  
for adults .....82–84  
for children .....106–107  
Occupant Classification  
Sensor .....79  
safety belt maintenance .....87  
warning light and chime .....88
- Safety seats for children .....110
- Safety Compliance  
Certification Label .....261
- Seat belts  
(see Safety restraints) .....77
- Seats .....69  
child safety seats .....110  
heated .....72
- SecuriLock passive anti-theft  
system .....64
- Servicing your vehicle .....223
- Setting the clock  
AM/FM single CD .....19  
AM/FM/In-dash 6 CD .....24
- Side-curtain airbags system  
(if equipped) .....103–104
- Snowplowing .....7
- Spark plugs, specifications .....259
- Special notice  
ambulance conversions .....7
- Specification chart,  
lubricants .....259
- Speed control .....50
- Starting your  
vehicle .....148–149, 151
- jump starting .....193
- Steering wheel  
tilting .....43
- T**
- Tilt steering wheel .....43
- Tires .....120–122  
alignment .....132  
care .....131  
changing .....182  
checking the pressure .....123  
inspecting and inflating .....123  
label .....130  
replacing .....125  
rotating .....133  
safety practices .....132  
sidewall information .....126  
snow tires and chains .....134  
spare tire .....181  
terminology .....122  
tire grades .....121  
treadwear .....121, 131
- Towing .....142  
recreational towing .....147  
trailer towing .....142  
wrecker .....198
- Transaxle  
fluid, checking and adding  
(manual) .....255  
manual operation .....162
- Transmission  
automatic operation .....157  
brake-shift interlock (BSI) ....157  
fluid, checking and adding  
(automatic) .....253  
fluid, refill capacities .....257
- Turn signal .....35
- V**
- Vehicle dimensions .....259

## Index

Vehicle Identification Number (VIN) .....	262	Windows	
Vehicle loading .....	135	power .....	47
Ventilating your vehicle .....	152	rear wiper/washer .....	43
<b>W</b>		Windshield washer fluid and wipers	
Warning lights (see Lights) .....	12	checking and adding fluid .....	228
Washer fluid .....	228	checking and cleaning ....	228–229
Water, Driving through .....	172	liftgate reservoir .....	228
		operation .....	42
		replacing wiper blades .....	229
		Wrecker towing .....	198